



|    |                                      |  |
|----|--------------------------------------|--|
| 6  | S.A. Backlight Ofis Armatürleri      |    |
| 7  | S.Ü. Backlight Ofis Armatürleri      |    |
| 8  | Özel/Mimari Ofis Armatürleri         |    |
| 9  | S.A./S.Ü. Backlight Ofis Armatürleri |    |
| 11 | Slim Paneller                        |    |
| 12 | Steril Armatürler                    |   |
| 13 | Konvansiyonel Armatürler             |  |
| 14 | Lineer Armatürler                    |  |
| 16 | Mimari Armatürler                    |  |
| 15 | Sarkıtlar                            |  |
| 20 | Backlight Downlightlar               |  |
| 21 | Backlight Downlightlar               |  |
| 22 | Slim Downlightlar                    |  |

Güncel ürün bilgi ve belgeleri için [www.pelsan.com.tr](http://www.pelsan.com.tr)'yi ziyaret ediniz.

|    |                            |   |  |   |   |   |
|----|----------------------------|---|--|---|---|---|
| 24 | Spotlar                    |    |     |    |    |  |
| 25 | Ray Spotlar                |    |     |    |    |   |
| 26 | Aplikler                   |    |     |    |    |  |
| 28 | Tavan Armatürleri          |    |    |    |    |  |
| 31 | IP66 Tavan Armatürleri     |    |    |    |    |   |
| 32 | Sensörlü Armatürler        |   |   |   |   |   |
| 34 | Sensörler                  |  |  |  |  |   |
| 35 | Acil Ayd./Yön. Armatürleri |  |   |  |  |   |
| 38 | Bant Armatürler            |  |  |  |  |   |
| 40 | Lineer Armatürler          |  |  |  |   |   |
| 42 | Etanjlar                   |  |  |  |  |   |
| 44 | Alüminyum Etanjlar         |  |  |  |   |   |
| 45 | Benzinlik Armatürleri      |  |  |  |   |   |

|    |                                |  |
|----|--------------------------------|--|
| 46 | Yüksek Tavan Armatürleri       |    |
| 49 | Yüksek Tavan Armatürleri       |    |
| 50 | Ex-Proof Armatürler            |    |
| 52 | Yüksek Güçlü Projektörler      |    |
| 53 | LED Projektörler               |    |
| 54 | LED Projektörler               |   |
| 58 | Konvansiyonel Projektörler     |  |
| 59 | Wallwasher                     |  |
| 60 | LED Yol ve Cadde Armatürleri   |  |
| 60 | LED Yol ve Cadde Armatürleri   |  |
| 61 | LED Yol ve Cadde Armatürleri   |  |
| 63 | Konv. Yol ve Cadde Armatürleri |  |
| 64 | Park Bahçe Armatürleri         |  |
| 65 | Park Bahçe Armatürleri         |  |

Güncel ürün bilgi ve belgeleri için [www.pelsan.com.tr](http://www.pelsan.com.tr)'yi ziyaret ediniz.

|     |                                |  |
|-----|--------------------------------|--|
| 69  | Park Bahçe Armatürleri         |    |
| 73  | Çimen Armatürleri              |    |
| 74  | Çimen Armatürleri              |    |
| 76  | Aplikler                       |    |
| 78  | Set Üstü Armatürler            |    |
| 80  | Bahçe Spotu & Gömme Armatürler |   |
| 81  | Şerit ve Neon LED              |  |
| 83  | Lambalar                       |  |
| 87  | Balastlar                      |  |
| 88  | Komponentler                   |  |
| 90  | Grup Prizler                   |  |
| 92  | Anahtarlar                     |  |
| 98  | Fırsat Ürünleri                |  |
| 104 | Belgeler                       |  |

Çevre ve Şehircilik Şartnamesine Uygun

Isoled

Dekoled

Poz No  
35.170.1000  
742-1000



Sıva Altı

Sıva Üstü

Alçıpan

Clip-in

**Isoled 60x60**  
Sıva Altı



IP 40 ● 4000K ● 6500K

| Kod No | Özellikler           | Koli Adedi | Fiyat    |
|--------|----------------------|------------|----------|
| 109460 | 36W 60X60 S.A. 4000K | 5          | 32,40 \$ |
| 109461 | 36W 60X60 S.A. 6500K | 5          | 32,40 \$ |

**Isoled 30x30**  
Sıva Altı



IP 40 ● 4000K ● 6500K

| Kod No | Özellikler           | Koli Adedi | Fiyat    |
|--------|----------------------|------------|----------|
| 108748 | 12W 30X30 S.A. 4000K | 5          | 27,80 \$ |
| 106163 | 12W 30X30 S.A. 6500K | 5          | 27,80 \$ |

**Isoled 30x60**  
Sıva Altı



IP 40 ● 4000K ● 6500K

| Kod No | Özellikler           | Koli Adedi | Fiyat    |
|--------|----------------------|------------|----------|
| 109738 | 17W 30x60 S.A. 4000K | 5          | 30,00 \$ |
| 109737 | 17W 30x60 S.A. 6500K | 5          | 30,00 \$ |

**Isoled 30x120**  
Sıva Altı



IP 40 ● 4000K ● 6500K

| Kod No | Özellikler            | Koli Adedi | Fiyat    |
|--------|-----------------------|------------|----------|
| 109739 | 36W 30x120 S.A. 4000K | 4          | 46,30 \$ |
| 109740 | 36W 30x120 S.A. 6500K | 4          | 46,30 \$ |

**Clipled 30x30**  
Clip-in



IP 40 ● 4000K ● 6500K

| Kod No | Özellikler              | Koli Adedi | Fiyat    |
|--------|-------------------------|------------|----------|
| 108084 | 20W 30X30 Clip-in 4000K | 20         | 19,70 \$ |

**Seoled1 60x60**  
Sıva Altı & Clip-in



IP 40 ● 4000K ● 6500K

| Kod No | Özellikler               | Koli Adedi | Fiyat    |
|--------|--------------------------|------------|----------|
| 109519 | 36W 60X60 S.A. 6500K     | 4          | 61,10 \$ |
| 109511 | 36W 60X60 Clip-in. 6500K | 4          | 64,60 \$ |

## Opsiyonlar

| Kod No | Özellikler                                     | Koli Adedi | Fiyat    |
|--------|--|------------|----------|
| 313118 | Isoled & Dekoled Acil Aydınlatma Kiti (1 saat) | 1          | 26,00 \$ |
| 316611 | Isoled & Dekoled Acil Aydınlatma Kiti (3 saat) | 1          | 30,30 \$ |
| 313527 | Isoled Alçıpan Yay (4 adet)                    | 1          | 3,40 \$  |

| Özellikler | Koli Adedi | Fiyat Farkı |
|------------|------------|-------------|
| Triac Dim  | 1          | 28,50 \$    |
| 1-10V Dim  | 1          | 56,50 \$    |
| DALI Dim   | 1          | 56,50 \$    |

**Dekoled 60x60**  
Sıva Üstü



IP 40 ● 4000K ● 6500K

| Kod No | Özellikler           | Koli Adedi | Fiyat    |
|--------|----------------------|------------|----------|
| 109464 | 36W 60X60 S.Ü. 4000K | 5          | 37,60 \$ |
| 109465 | 36W 60X60 S.Ü. 6500K | 5          | 37,60 \$ |

**60x60 Radar Sensörlü**  
Sıva Üstü



IP 40 ● 4000K ● 6500K

55mm

Acil

| Kod No | Özellikler                                       | Koli Adedi | Fiyat    |
|--------|--|------------|----------|
| 108786 | 36W 60x60 S.Ü. 6500K Radar Sens.                 | 5          | 52,90 \$ |
| 108785 | 36W 60x60 S.Ü. 6500K Radar Sens. + Acil Ayd. Kit | 5          | 78,90 \$ |

**Dekoled 30x30**  
Sıva Üstü



IP 40 ● 4000K ● 6500K

55mm

| Kod No | Özellikler           | Koli Adedi | Fiyat    |
|--------|----------------------|------------|----------|
| 108393 | 12W 30x30 S.Ü. 4000K | 5          | 31,90 \$ |
| 108392 | 12W 30x30 S.Ü. 6500K | 5          | 31,90 \$ |

**30x30 Radar Sensörlü**  
Sıva Üstü



IP 40 ● 4000K ● 6500K

55mm

Acil

| Kod No | Özellikler                                       | Koli Adedi | Fiyat    |
|--------|--|------------|----------|
| 108780 | 12W 30x30 S.Ü. 4000K Radar Sens.                 | 5          | 47,20 \$ |
| 109086 | 12W 30x30 S.Ü. 6500K Radar Sens. + Acil Ayd. Kit | 5          | 73,20 \$ |

**Dekoled 60x120**  
Sıva Üstü



IP 40 ● 4000K ● 6500K

55mm

| Kod No | Özellikler            | Koli Adedi | Fiyat     |
|--------|-----------------------|------------|-----------|
| 108953 | 84W 60x120 S.Ü. 6500K | 2          | 141,50 \$ |

**Seoled1 60x60**  
Sıva Üstü



IP 40 ● 4000K ● 6500K

69mm

| Kod No | Özellikler           | Koli Adedi | Fiyat    |
|--------|----------------------|------------|----------|
| 109516 | 36W 60X60 S.Ü. 6500K | 4          | 66,30 \$ |

**Dekoled 30x120**  
Sıva Üstü



IP 40 ● 4000K ● 6500K

55mm

| Kod No | Özellikler            | Koli Adedi | Fiyat    |
|--------|-----------------------|------------|----------|
| 109754 | 36W 30x120 S.Ü. 4000K | 4          | 52,50 \$ |
| 109755 | 36W 30x120 S.Ü. 6500K | 4          | 52,50 \$ |

**Dekoled 30x60**  
Sıva Üstü



IP 40 ● 4000K ● 6500K

55mm

| Kod No | Özellikler           | Koli Adedi | Fiyat    |
|--------|----------------------|------------|----------|
| 109747 | 17W 30x60 S.Ü. 4000K | 5          | 34,20 \$ |
| 109748 | 17W 30x60 S.Ü. 6500K | 5          | 34,20 \$ |

# Pelsan Sıva Altı ve Sıva Üstü Backlight Ofis Armatürleri

## Isoled 125 lm/W

Sıva Altı



IP 40 ● 3000K ● 4000K ● 6500K

40mm

| Kod No | Özellikler                    | Koli Adedi | Fiyat    |
|--------|-------------------------------|------------|----------|
| 109470 | 36W 60x60 S.A. 4000K 125 lm/W | 5          | 46,70 \$ |
| 109471 | 36W 60x60 S.A. 6500K 125 lm/W | 5          | 46,70 \$ |

## Dekoled 125 lm/W

Sıva Üstü



IP 40 ● 3000K ● 4000K ● 6500K

65mm

| Kod No | Özellikler                    | Koli Adedi | Fiyat    |
|--------|-------------------------------|------------|----------|
| 109474 | 36W 60x60 S.U. 4000K 125 lm/W | 5          | 52,00 \$ |
| 109475 | 36W 60x60 S.U. 6500K 125 lm/W | 5          | 52,00 \$ |

## Parled

Sıva Altı



## Maksimum Performans Maksimum Konfor!

Yeni Ürün

- 110 lm/W
- Kamaşma kontrollü tasarım
- Estetik görünüm

IP 40 ● 3000K ● 4000K ● 6500K

| Kod No | Özellikler           | Koli Adedi | Fiyat    |
|--------|----------------------|------------|----------|
| 109729 | 36W 60x60 S.A. 4000K | 4          | 83,30 \$ |
| 109730 | 36W 60x60 S.A. 6500K | 4          | 83,30 \$ |

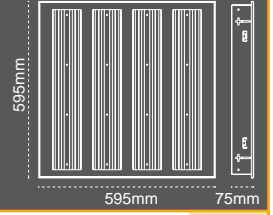

## Divaled

Sıva Altı



Soft Işık

**Kolay ve Hızlı Montaj**  
Fonksiyonel tasarımı sayesinde elektriksel bağlantısı kolay ve hızlı yapılır.

## İşığın Soft Hali!

- Endirekt tasarım ile soft aydınlatma sağlar
- Kamaşma kontrollü tasarım
- Estetik görünüm

IP 40

| Kod No | Özellikler           | Koli Adedi | Fiyat    |
|--------|----------------------|------------|----------|
| 108125 | 42W 60x60 S.A. 4000K | 4          | 91,70 \$ |
| 108408 | 42W 60x60 S.A. 6500K | 4          | 91,70 \$ |

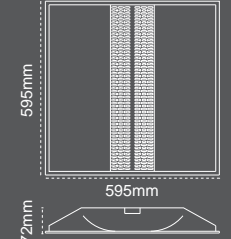

## Isoled Ambiyans

Sıva Altı

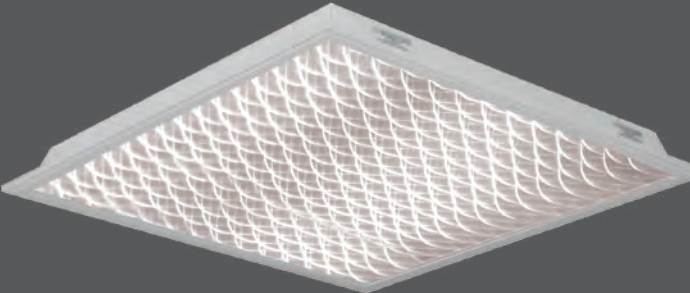

## Özel Işık Hareleri!

- Isoled Ambiyans, özel difüzörü sayesinde farklı açılardan farklı ışık hareleri sunar.

IP 40 ● 3000K ● 4000K ● 6500K

| Kod No | Özellikler                     | Koli Adedi | Fiyat    |
|--------|--------------------------------|------------|----------|
| 108958 | 12W 30X30 S.A. 6500K Ambiyans  | 5          | 39,40 \$ |
| 108959 | 17W 30X60 S.A. 6500K Ambiyans  | 5          | 45,10 \$ |
| 108960 | 33W 60X60 S.A. 6500K Ambiyans  | 5          | 56,30 \$ |
| 108962 | 42W 60X60 S.A. 6500K Ambiyans  | 5          | 56,30 \$ |
| 108963 | 42W 30X120 S.A. 6500K Ambiyans | 4          | 56,30 \$ |

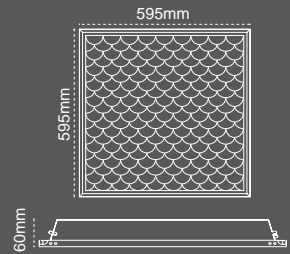



# Sıva Altı ve Sıva Üstü Backlight Ofis Armatürleri

**Seoled4**  
Sıva Altı **Yeni Ürün**



IP 40  ● 4000K ● 6500K

| Kod No | Özellikler           | Koli Adedi | Fiyat    |
|--------|----------------------|------------|----------|
| 109234 | 36W 60X60 S.A. 6500K | 4          | 61,10 \$ |

**Seoled4**  
Sıva Üstü **Yeni Ürün**



IP 40  ● 4000K ● 6500K

| Kod No | Özellikler           | Koli Adedi | Fiyat    |
|--------|----------------------|------------|----------|
| 109236 | 36W 60X60 S.Ü. 6500K | 4          | 66,30 \$ |

**Seoled3**  
Sıva Altı 



IP 40  ● 4000K ● 6500K

| Kod No | Özellikler           | Koli Adedi | Fiyat    |
|--------|----------------------|------------|----------|
| 109521 | 36W 60X60 S.A. 6500K | 4          | 61,10 \$ |

**Seoled3**  
Sıva Üstü 



IP 40  ● 4000K ● 6500K

| Kod No | Özellikler           | Koli Adedi | Fiyat    |
|--------|----------------------|------------|----------|
| 109518 | 36W 60X60 S.Ü. 6500K | 4          | 66,30 \$ |

**Seoled2**  
Sıva Altı 

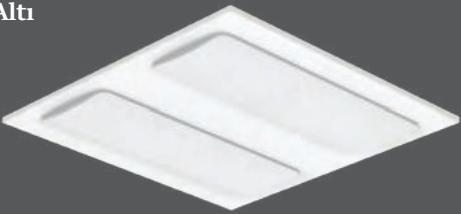

IP 40  ● 4000K ● 6500K

| Kod No | Özellikler           | Koli Adedi | Fiyat    |
|--------|----------------------|------------|----------|
| 109520 | 36W 60X60 S.A. 6500K | 4          | 61,10 \$ |

**Seoled2**  
Sıva Üstü 

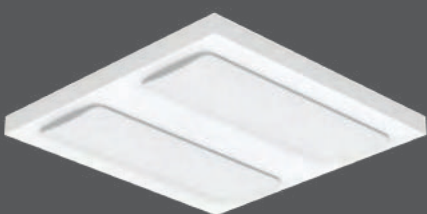

IP 40  ● 4000K ● 6500K

| Kod No | Özellikler           | Koli Adedi | Fiyat    |
|--------|----------------------|------------|----------|
| 109517 | 36W 60X60 S.Ü. 6500K | 4          | 66,30 \$ |

**Seoled1**  
Sıva Altı 



IP 40  ● 4000K ● 6500K

| Kod No | Özellikler           | Koli Adedi | Fiyat    |
|--------|----------------------|------------|----------|
| 109519 | 36W 60X60 S.A. 6500K | 4          | 61,10 \$ |

**Seoled1**  
Sıva Üstü 



IP 40  ● 4000K ● 6500K

| Kod No | Özellikler           | Koli Adedi | Fiyat    |
|--------|----------------------|------------|----------|
| 109516 | 36W 60X60 S.Ü. 6500K | 4          | 66,30 \$ |

## Opsiyon Farkları

| Kod No | Özellikler                                  | Koli Adedi | Fiyat    |
|--------|---|------------|----------|
| 313118 | Seoled-Fioled Acil Aydınlatma Kiti (1 saat) | 1          | 26,00 \$ |
| 316611 | Seoled-Fioled Acil Ayd. Kiti (3 saat)       | 1          | 30,30 \$ |
| 313527 | Alçıpan Yayı (4 adet)                       | 1          | 3,40 \$  |

Müşteriye Özel Tasarımlar



Projelere  
Özel Tasarımlar



Logo Uygulamaları



Minimum Sipariş Miktarı: 50 Adet

## Halley LED

60x60 Sıva Altı

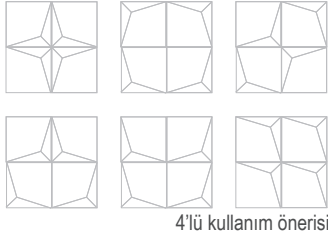

4'lü kullanım önerisi

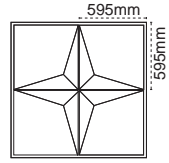

IP 40 4000K 6500K

| Kod No | Özellikler           | Koli Adedi | Fiyat     |
|--------|----------------------|------------|-----------|
| 109834 | 36W 60x60 S.A. 6500K | 4          | 101,30 \$ |

## Galaxy LED

60x60 Sıva Altı

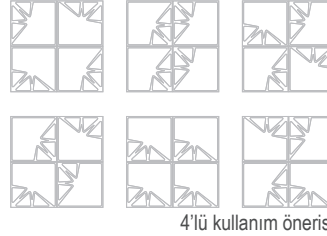
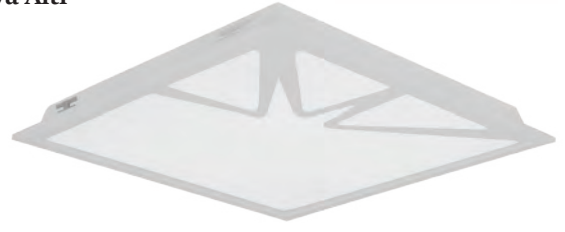

4'lü kullanım önerisi

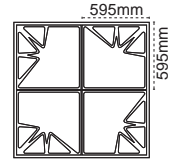

IP 40 4000K 6500K

| Kod No | Özellikler           | Koli Adedi | Fiyat    |
|--------|----------------------|------------|----------|
| 109835 | 36W 60x60 S.A. 6500K | 5          | 78,80 \$ |

## Cion LED

60x60 Sıva Altı

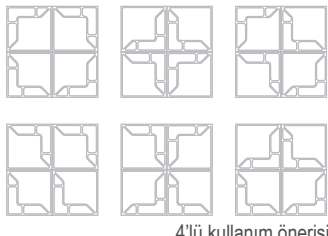

4'lü kullanım önerisi

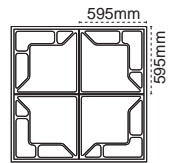

IP 40 4000K 6500K

| Kod No | Özellikler           | Koli Adedi | Fiyat    |
|--------|----------------------|------------|----------|
| 109836 | 36W 60x60 S.A. 6500K | 5          | 78,80 \$ |

## Gupur LED

60x60 Sıva Altı

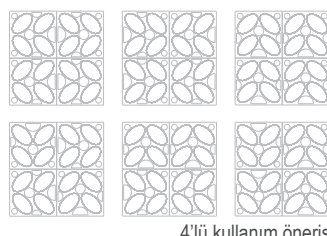

4'lü kullanım önerisi

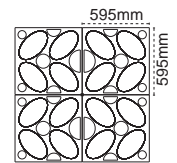

IP 40 4000K 6500K

| Kod No | Özellikler           | Koli Adedi | Fiyat    |
|--------|----------------------|------------|----------|
| 109837 | 36W 60x60 S.A. 6500K | 5          | 78,80 \$ |

## Mioled Sıva Altı



IP 40

| Kod No | Özellikler                | Koli Adedi | Fiyat    |
|--------|---------------------------|------------|----------|
| 106071 | 36W 60X60 3000K Sıva Altı | 5          | 35,70 \$ |
| 106073 | 36W 60X60 6500K Sıva Altı | 5          | 35,70 \$ |
| 106089 | 36W 60X60 3000K Clip-in   | 5          | 39,80 \$ |
| 106090 | 36W 60X60 4000K Clip-in   | 5          | 39,80 \$ |
| 106093 | 36W 60X60 6500K Clip-in   | 5          | 39,80 \$ |
| 107966 | 48W 60X60 4000K Sıva Altı | 5          | 56,70 \$ |
| 107967 | 48W 60X60 6500K Sıva Altı | 5          | 56,70 \$ |

## Mioled 30x Serisi Sıva Altı



IP 40

| Kod No | Özellikler              | Koli Adedi | Fiyat    |
|--------|-------------------------|------------|----------|
| 108104 | 20W 30x30 3000K Clip-in | 10         | 27,30 \$ |
| 108029 | 20W 30x30 4000K Clip-in | 10         | 27,30 \$ |
| 108087 | 30W 30X60 3000K         | 5          | 38,50 \$ |
| 108025 | 30W 30X60 4000K         | 5          | 38,50 \$ |

## Calisto Sıva Üstü 48W Yeni Ürün



IP 40

| Kod No | Özellikler              | Koli Adedi | Fiyat     |
|--------|-------------------------|------------|-----------|
| 109576 | 48W Ø60X60cm 6500K S.U. | 4          | 106,90 \$ |

## Calisto Sıva Altı / Sıva Üstü 48W Yeni Ürün



IP 40

| Kod No | Özellikler           | Ømm   | Koli Adedi | Fiyat     |
|--------|----------------------|-------|------------|-----------|
| 108252 | 48W Ø60cm 6500K S.A. | 585mm | 5          | 94,90 \$  |
| 109128 | 48W Ø60cm 6500K S.U. |       | 4          | 106,90 \$ |

## Mioled Aura Sıva Altı 45W

**Mioled Aura ile Kontrol Sizde!**

Mioled Aura kontrol kumandasıyla dim edilir. Renk sıcaklığı ayarlanır.

| Uygunluk | Özellikler | Dahildir |
|----------|------------|----------|
| 2700K    | 3000K      | 4100K    |
| SABAH    | ÖĞLEN      | AKŞAM    |



IP 40

| Kod No | Özellikler     | Koli Adedi | Fiyat     |
|--------|----------------|------------|-----------|
| 108161 | 45W 60X60 Aura | 5          | 123,10 \$ |

## Mioled Speaker Sıva Altı 40W

**Mioled Speaker ile...**

Günlük aydınlatma düzeninizi hareketlendirin.



IP 40

| Kod No | Özellikler        | Koli Adedi | Fiyat     |
|--------|-------------------|------------|-----------|
| 108153 | 40W 60X60 Speaker | 5          | 123,10 \$ |

## Sıva Üstü Çerçeve Aparatı Duo



IP 40

| Kod No | Özellikler                             | Koli Adedi | Fiyat    |
|--------|--|------------|----------|
| 311266 | 60X60 Slim Panel S.Ü. Çerçeve Aparatı  | 4          | 10,90 \$ |
| 311267 | 30X30 Slim Panel S.Ü. Çerçeve Aparatı  | 4          | 7,50 \$  |
| 311268 | 30X60 Slim Panel S.Ü. Çerçeve Aparatı  | 4          | 8,70 \$  |
| 311269 | 30X120 Slim Panel S.Ü. Çerçeve Aparatı | 4          | 11,90 \$ |

## Clip-in Çerçeve Aparatı



IP 40

| Kod No | Özellikler                               | Koli Adedi | Fiyat   |
|--------|--|------------|---------|
| 316484 | 60X60 Slim Panel Clip-in Çerçeve Aparatı | 5          | 6,90 \$ |
| 316582 | 30X30 Slim Panel Clip-in Çerçeve Aparatı | 2          | 5,80 \$ |

**IP65 LED Steril**  
Sıva Altı Temperli Kumlu Camlı



IP65

IP 65 3000K 4000K 6500K

| Kod No | Özellikler                       | Koli Adedi | Fiyat     |
|--------|----------------------------------|------------|-----------|
| 109776 | 36W 60x60 S.A. 4000K IP65 Steril | 2          | 112,60 \$ |
| 109777 | 36W 60x60 S.A. 6500K IP65 Steril | 2          | 112,60 \$ |

**Mikrop Kırıcı**  
Sıva Üstü



axbxcmm

|       |             |
|-------|-------------|
| 1x15W | 535x121x126 |
| 1x30W | 990x121x126 |

IP 20

| Kod No | Özellikler  | Koli Adedi | Fiyat    |
|--------|-------------|------------|----------|
| 101028 | 1x15W 535mm | 4          | 45,70 \$ |
| 101031 | 1x30W 990mm | 4          | 60,60 \$ |

**IP65 Mioled**  
Sıva Altı 60x60



IP65

IP 65

| Kod No | Özellikler                | Koli Adedi | Fiyat     |
|--------|---------------------------|------------|-----------|
| 108152 | 40W 60x60 S.A. 6500K IP65 | 5          | 101,30 \$ |

**Negatoskop**  
Sıva Üstü



678mm 103mm 500mm

IP 65 4000K 6500K

| Kod No | Özellikler               | Koli Adedi | Fiyat     |
|--------|--------------------------|------------|-----------|
| 106101 | 42W LED 60X60 S.Ü.6500K  | 1          | 181,70 \$ |
| 106103 | 84W LED 60X120 S.Ü.6500K | 1          | 250,40 \$ |

**IP65 Steril**  
Sıva Altı Temperli Camlı



IP65

IP 65

| Kod No | Özellikler                            | Koli Adedi | Fiyat    |
|--------|---------------------------------------|------------|----------|
| 100743 | 2X18W TLD Elk. Bal. S.A. Kumlu Camlı  | 4          | 61,00 \$ |
| 100752 | 4X18W TLD Elk. Bal. S.A. Kumlu Camlı  | 3          | 64,40 \$ |
| 100765 | 2X36W TLD Elk. Bal. S.A. Kumlu Camlı  | 3          | 76,20 \$ |
| 101364 | 2X18W TLD Elk. Bal. S.A. Şeffaf Camlı | 4          | 66,00 \$ |
| 101324 | 4X18W TLD Elk. Bal. S.A. Şeffaf Camlı | 3          | 80,30 \$ |
| 101373 | 2X36W TLD Elk. Bal. S.A. Şeffaf Camlı | 3          | 83,50 \$ |

**IP65 Steril**  
Sıva Üstü Temperli Camlı

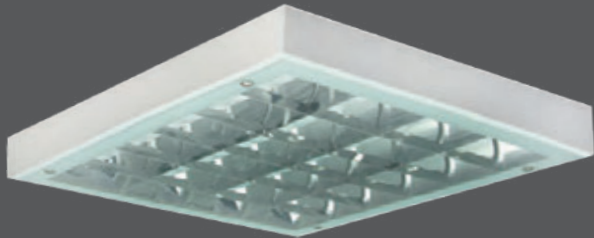

IP65

IP 65

| Kod No | Özellikler                            | Koli Adedi | Fiyat    |
|--------|---------------------------------------|------------|----------|
| 100706 | 2X18W TLD Elk. Bal. S.Ü. Kumlu Camlı  | 4          | 65,20 \$ |
| 100714 | 4X18W TLD Elk. Bal. S.Ü. Kumlu Camlı  | 4          | 76,80 \$ |
| 100722 | 2X36W TLD Elk. Bal. S.Ü. Kumlu Camlı  | 4          | 80,30 \$ |
| 100993 | 2X18W TLD Elk. Bal. S.Ü. Şeffaf Camlı | 4          | 70,10 \$ |
| 101003 | 4X18W TLD Elk. Bal. S.Ü. Şeffaf Camlı | 4          | 84,40 \$ |
| 101016 | 2X36W TLD Elk. Bal. S.Ü. Şeffaf Camlı | 4          | 87,70 \$ |



| Kod No | Özellikler               | Koli Adedi | Fiyat    |
|--------|--------------------------|------------|----------|
| 101148 | 2X18W TLD Elk. Bal. S.A. | 4          | 40,80 \$ |
| 101176 | 4X18W TLD Elk. Bal. S.A. | 4          | 45,20 \$ |
| 101217 | 2X36W TLD Elk. Bal. S.A. | 4          | 45,20 \$ |



| Kod No | Özellikler               | Koli Adedi | Fiyat    |
|--------|--------------------------|------------|----------|
| 101843 | 2X18W TLD Elk. Bal. S.Ü. | 6          | 43,00 \$ |
| 101881 | 4X18W TLD Elk. Bal. S.Ü. | 6          | 47,50 \$ |
| 101922 | 2X36W TLD Elk. Bal. S.Ü. | 4          | 47,50 \$ |



| Kod No | Özellikler               | Lens      | Koli Adedi | Fiyat    |
|--------|--------------------------|-----------|------------|----------|
| 100566 | 2X18W TLD Elk. Bal. S.A. | Prizmatik | 4          | 39,60 \$ |
| 100583 | 4X18W TLD Elk. Bal. S.A. | Prizmatik | 4          | 44,20 \$ |
| 100602 | 2X36W TLD Elk. Bal. S.A. | Prizmatik | 4          | 44,20 \$ |
| 101586 | 2X18W TLD Elk. Bal. S.A. | Opal      | 4          | 44,20 \$ |
| 101597 | 4X18W TLD Elk. Bal. S.A. | Opal      | 4          | 48,60 \$ |
| 101612 | 2X36W TLD Elk. Bal. S.A. | Opal      | 4          | 48,60 \$ |



| Kod No | Özellikler               | Lens      | Koli Adedi | Fiyat    |
|--------|--------------------------|-----------|------------|----------|
| 101045 | 2X18W TLD Elk. Bal. S.Ü. | Prizmatik | 6          | 41,90 \$ |
| 101057 | 4X18W TLD Elk. Bal. S.Ü. | Prizmatik | 6          | 46,40 \$ |
| 101076 | 2X36W TLD Elk. Bal. S.Ü. | Prizmatik | 4          | 46,40 \$ |
| 101970 | 2X18W TLD Elk. Bal. S.Ü. | Opal      | 6          | 46,40 \$ |
| 101981 | 4X18W TLD Elk. Bal. S.Ü. | Opal      | 6          | 50,80 \$ |
| 101994 | 2X36W TLD Elk. Bal. S.Ü. | Opal      | 4          | 50,80 \$ |

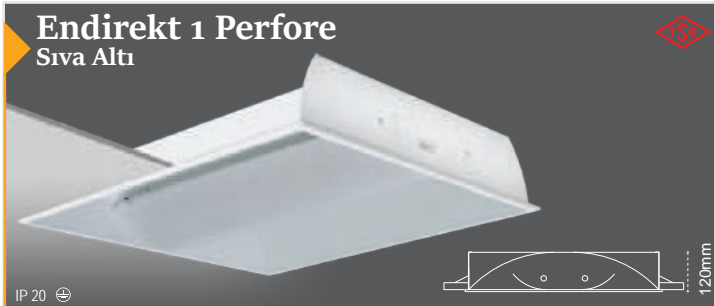

| Kod No | Özellikler              | Koli Adedi | Fiyat    |
|--------|-------------------------|------------|----------|
| 108378 | 3X24W T5 Elk. Bal. S.A. | 3          | 82,40 \$ |
| 102121 | 2X24W T5 Elk. Bal. S.A. | 3          | 71,20 \$ |



| Kod No | Özellikler              | Koli Adedi | Fiyat    |
|--------|-------------------------|------------|----------|
| 102297 | 2X24W T5 Elk. Bal. S.Ü. | 3          | 75,80 \$ |
| 102300 | 3X24W T5 Elk. Bal. S.Ü. | 3          | 85,70 \$ |



| Kod No | Özellikler              | Koli Adedi | Fiyat    |
|--------|-------------------------|------------|----------|
| 100891 | 2X14W T5 Elk. Bal. S.A. | 6          | 41,20 \$ |
| 100896 | 3X14W T5 Elk. Bal. S.A. | 6          | 47,40 \$ |
| 100908 | 4X14W T5 Elk. Bal. S.A. | 6          | 47,40 \$ |
| 100963 | 2X28W T5 Elk. Bal. S.A. | 4          | 47,40 \$ |
| 101701 | 4X14W T5 Elk. Clip-in   | 6          | 49,60 \$ |



| Kod No | Özellikler              | Koli Adedi | Fiyat    |
|--------|-------------------------|------------|----------|
| 101467 | 2X14W T5 Elk. Bal. S.Ü. | 6          | 43,40 \$ |
| 101480 | 4X14W T5 Elk. Bal. S.Ü. | 6          | 49,60 \$ |
| 101498 | 2X28W T5 Elk. Bal. S.Ü. | 4          | 49,60 \$ |

**Eterna**

**Sonsuzluğa Uzanan  
Konforlu Aydınlatma**



- LED Çip ( LM80-TM218)
- ENEC Belgeli Sürücü
- Acil Aydınlatma
- DALI Opsiyonu

**Sonsuz Linear Bağlantı**

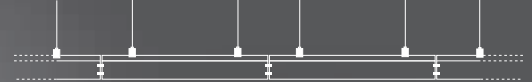

Bağlantı aparatları ile ürüne müdahale edilmeksizin dışardan kesintisiz linear bağlantı yapılır.

**Tüm Tavan Tiplerine Uygun**

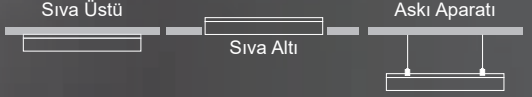

RAL 9005

RAL 9006

RAL 9016



**Eterna (57mm)  
Sıva Üstü**



IP 40 ● 3000K ● 4000K ● 6500K

| Kod No | Özellikler      | Koli Adedi | Fiyat    |
|--------|-----------------|------------|----------|
| 108964 | 14W 4000K 600mm | 1          | 39,40 \$ |
| 108965 | 20W 4000K 900mm | 1          | 51,80 \$ |

IP 40 ● 3000K ● 4000K ● 6500K

| Kod No | Özellikler       | Koli Adedi | Fiyat    |
|--------|------------------|------------|----------|
| 108966 | 28W 4000K 1200mm | 1          | 63,10 \$ |
| 108967 | 42W 4000K 1500mm | 1          | 84,40 \$ |

**Eterna (57mm)  
Sıva Altı**

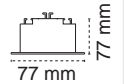

IP 20 ● 3000K ● 4000K ● 6500K

| Kod No | Özellikler      | mm     | Koli Adedi | Fiyat    |
|--------|-----------------|--------|------------|----------|
| 108898 | 14W 4000K 630mm | 610X62 | 1          | 39,40 \$ |
| 108899 | 20W 4000K 920mm | 890X62 | 1          | 51,80 \$ |

IP 20 ● 3000K ● 4000K ● 6500K

| Kod No | Özellikler       | mm      | Koli Adedi | Fiyat    |
|--------|------------------|---------|------------|----------|
| 108900 | 28W 4000K 1230mm | 1210X62 | 1          | 63,10 \$ |
| 108901 | 42W 4000K 1510mm | 1490X62 | 1          | 84,40 \$ |

**Opsiyon Farkları**

| Kod No | Özellikler                                 | Koli Adedi | Fiyat  |
|--------|--|------------|--------|
| 304906 | Askı Aparatı 100 cm (2 adet)               | 1          | 4,30\$ |
| 304915 | Askı Aparatı 150 cm (2 adet)               | 1          | 5,30\$ |
| 317986 | Askı Rozans Takımı 150 cm Siyah (2 adet)   | 1          | 5,30\$ |
| 205224 | Linear Birleştirme Aparatı Takımı (2 adet) | 1          | 2,20\$ |

## Trenta LED (36mm) Sarkıt



- 1m askı aparatı dahildir.

IP 40   4000K  6500K

| Kod No | Özellikler       | Koli Adedi | Fiyat    |
|--------|------------------|------------|----------|
| 102955 | 25W 4000K 1200mm | 12         | 46,20 \$ |
| 108078 | 25W 6500K 1200mm | 12         | 46,20 \$ |

## Sirenta LED (36mm) Sarkıt



- 1m askı aparatı dahildir.

IP 40   4000K  6500K

| Kod No | Özellikler       | Koli Adedi | Fiyat    |
|--------|------------------|------------|----------|
| 107912 | 25W 4000K 1200mm | 12         | 47,30 \$ |
| 102956 | 25W 6500K 1200mm | 12         | 47,30 \$ |

## Recta Lux LED (85mm) Sıva Üstü



IP 40   3000K  4000K  6500K

| Kod No | Özellikler       | Koli Adedi | Fiyat     |
|--------|------------------|------------|-----------|
| 108083 | 17W 4000K 600mm  | 1          | 50,70 \$  |
| 106333 | 25W 4000K 900mm  | 1          | 93,40 \$  |
| 106340 | 36W 4000K 1200mm | 1          | 101,30 \$ |
| 106347 | 45W 4000K 1500mm | 1          | 112,60 \$ |

## Recta Lux LED (85 mm) Sıva Altı



IP 40   3000K  4000K  6500K

| Kod No | Özellikler       | mm      | Koli Adedi | Fiyat     |
|--------|------------------|---------|------------|-----------|
| 109028 | 17W 4000K 610mm  | 600x90  | 1          | 56,30 \$  |
| 106358 | 25W 4000K 910mm  | 902x90  | 1          | 95,70 \$  |
| 106362 | 36W 4000K 1230mm | 1220x90 | 1          | 106,90 \$ |
| 106366 | 45W 4000K 1510mm | 1510x90 | 1          | 118,20 \$ |

## Brilla Sıva Üstü



IP 40   3000K  4000K  6500K

| Kod No | Özellikler       | Koli Adedi | Fiyat    |
|--------|------------------|------------|----------|
| 109026 | 28W 4000K 1210mm | 1          | 87,50 \$ |

## Clear Sıva Üstü



IP 40   4000K  6500K

| Kod No | Özellikler       | Koli Adedi | Fiyat    |
|--------|------------------|------------|----------|
| 108235 | 36W 6500K 1210mm | 6          | 36,40 \$ |

## Circa



RAL 9005  
RAL 9006  
RAL 9016

- 3 adet 1.5m ayarlanabilir askı aparatı dahildir.

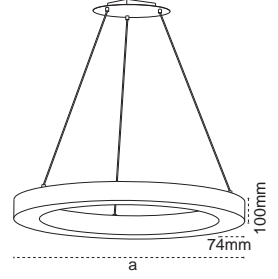

IP 40 ● 3000K ● 4000K ● 6500K

| Kod No | Ozellikler                               | Koli Adedi | Fiyat     |
|--------|--|------------|-----------|
| 105796 | 45W 4000K 600mm RAL 9006                 | 1          | 157,60 \$ |
| 108201 | 65W 4000K 900mm RAL 9006                 | 1          | 262,60 \$ |
| 108202 | 100W 4000K 1200mm RAL 9006               | 1          | 367,60 \$ |
| 109139 | 90W 4000K 1500mm RAL 9006                | 1          | 420,10 \$ |
| 317028 | Circa-Polaris Askı Rozansı 1'li RAL 9006 | 1          | 5,30 \$   |
| 316738 | Circa-Polaris Askı Rozansı 3'lü RAL 9006 | 1          | 13,20 \$  |

## Polaris



RAL 9005  
RAL 9006  
RAL 9016

- 3 adet 1.5m ayarlanabilir askı aparatı dahildir.

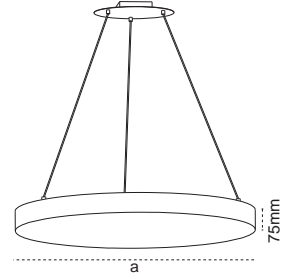

IP 40 ● 3000K ● 4000K ● 6500K

| Kod No | Ozellikler                               | Koli Adedi | Fiyat     |
|--------|--|------------|-----------|
| 105807 | 40W 4000K 400mm RAL 9006                 | 1          | 105,10 \$ |
| 105814 | 60W 4000K 600mm RAL 9006                 | 1          | 147,10 \$ |
| 105818 | 70W 4000K 900mm RAL 9006                 | 1          | 231,10 \$ |
| 109140 | 120W 4000K 1200mm RAL 9006               | 1          | 367,60 \$ |
| 317028 | Circa-Polaris Askı Rozansı 1'li RAL 9006 | 1          | 5,30 \$   |

## Circa



RAL 9005  
RAL 9006  
RAL 9016

- 3 adet 1.5m ayarlanabilir askı aparatı dahildir.

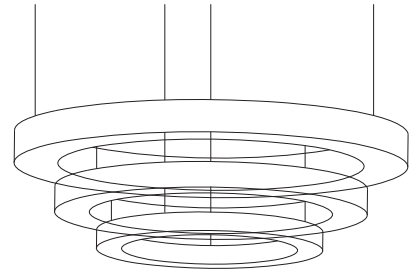

IP 40 ● 3000K ● 4000K ● 6500K

| Kod No | Ozellikler                               | Koli Adedi | Fiyat     |
|--------|--|------------|-----------|
| 105796 | 45W 4000K 600mm RAL 9006                 | 1          | 157,60 \$ |
| 108201 | 65W 4000K 900mm RAL 9006                 | 1          | 262,60 \$ |
| 108202 | 100W 4000K 1200mm RAL 9006               | 1          | 367,60 \$ |
| 109139 | 90W 4000K 1500mm RAL 9006                | 1          | 420,10 \$ |
| 317028 | Circa-Polaris Askı Rozansı 1'li RAL 9006 | 1          | 5,30 \$   |
| 316738 | Circa-Polaris Askı Rozansı 3'lü RAL 9006 | 1          | 13,20 \$  |



## Quad

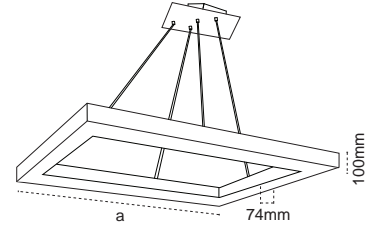

IP 40 ☺

| Kod No | Özellikler                              | Koli Adedi | Fiyat     |
|--------|---|------------|-----------|
| 108513 | 20W 4000K 400x400mm RAL 9006            | 1          | 122,90 \$ |
| 106298 | 75W 4000K 600x600mm RAL 9006            | 1          | 188,00 \$ |
| 106307 | 100W 4000K 900x900mm RAL 9006           | 1          | 296,20 \$ |
| 317383 | Quad - Detra Askı Rozansı 1'li RAL 9006 | 1          | 5,30 \$   |
| 317148 | Quad Askı Rozansı 3'li RAL 9006         | 1          | 10,60 \$  |

RAL 9005

RAL 9006

RAL 9016

● 4 adet 1.5m ayarlanabilir askı aparatı dahildir.

## Detra

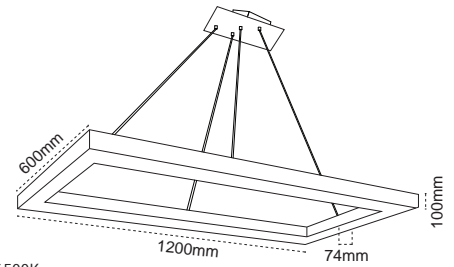

IP 65 ☺

● 3000K ● 4000K ● 6500K

| Kod No | Özellikler                              | Koli Adedi | Fiyat     |
|--------|---|------------|-----------|
| 109149 | 100W 4000K 600x1200 mm RAL 9006         | 1          | 252,10 \$ |
| 317383 | Quad - Detra Askı Rozansı 1'li RAL 9006 | 1          | 5,30 \$   |
| 317148 | Quad Askı Rozansı 3'li RAL 9006         | 1          | 10,60 \$  |

RAL 9005

RAL 9006

RAL 9016

● 4 adet 1.5m ayarlanabilir askı aparatı dahildir.

## Twist

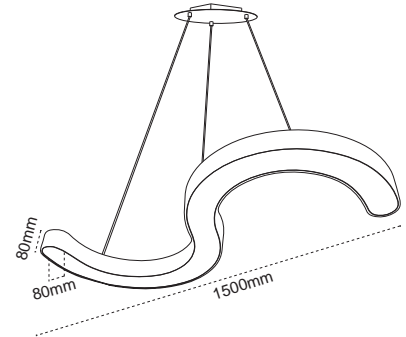

IP 40 ☺

● 3000K ● 4000K ● 6500K

| Kod No | Özellikler                | Koli Adedi | Fiyat     |
|--------|---------------------------|------------|-----------|
| 109130 | 45W 4000K 1500mm RAL 9006 | 1          | 262,60 \$ |

RAL 9005

RAL 9006

RAL 9016

● 3 adet 1.5m ayarlanabilir askı aparatı dahildir.

## Tria

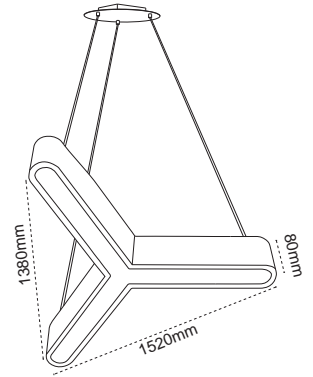

IP 40 ☺

● 3000K ● 4000K ● 6500K

| Kod No | Özellikler             | Koli Adedi | Fiyat     |
|--------|------------------------|------------|-----------|
| 109141 | 130W 4000K 1300x1500mm | 1          | 367,60 \$ |

RAL 9005

RAL 9006

RAL 9016

● 3 adet 1.5m ayarlanabilir askı aparatı dahildir.



**Pico**  
103782

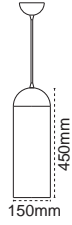

**Rodos**  
103777

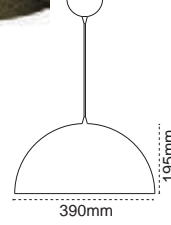

**Avsha**  
103774

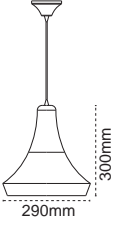

RAL 9005  
RAL 9006  
RAL 9016



**Sana**  
104282

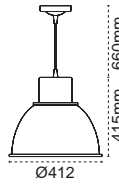

**Tuna**  
104278

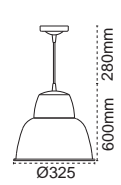

## Dekoratif Sarkıt Armatürler

IP 20 ● 3000K ● 4000K ● 6500K

| Kod No | Ozellikler            | Koli Adedi | Fiyat    |
|--------|-----------------------|------------|----------|
| 103782 | Pico E27 Black        | 4          | 29,50 \$ |
| 103777 | Rodos E27 Altın Oksit | 4          | 29,50 \$ |
| 103774 | Avsha E27 Gri         | 4          | 29,50 \$ |

| Kod No | Ozellikler | Koli Adedi | Fiyat    |
|--------|------------|------------|----------|
| 104282 | Sana E27   | 12         | 31,60 \$ |
| 104278 | Tuna E27   | 12         | 22,10 \$ |

**Yeni****Dekoratif Sarkıt Armatürler**

## Dekoratif Sarkıt Armatürler

IP 20 ⊕ ● 3000K ● 4000K ● 6500K

| Kod No | Özellikler        | Koli Adedi | Fiyat    | Kod No | Özellikler                | Koli Adedi | Fiyat    |
|--------|-------------------|------------|----------|--------|---------------------------|------------|----------|
| 109580 | Pyramid E27 Siyah | 10         | 19,50 \$ | 104235 | Volga E27 Gümüş           | 6          | 42,10 \$ |
| 109581 | Ring E27 Siyah    | 10         | 19,50 \$ | 106638 | Volga 50W 4000K LED Gümüş | 6          | 90,10 \$ |
| 109582 | Diamond E27 Siyah | 10         | 19,50 \$ | 108972 | Simi E27 Beyaz            | 4          | 29,50 \$ |

# Pelsan Sıva Altı Backlight LED Downlight Armatürler

## Tira Alüminyum Enjeksiyon Sıva Altı

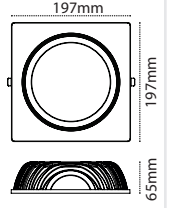
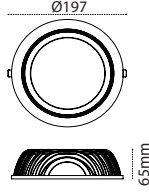

IP 40 ⊕ ● 3000K ● 4000K ● 6500K

| Kod No | Özellikler | Ø mm | Koli Adedi | Fiyat    |
|--------|------------|------|------------|----------|
| 109708 | 12W 4000K  | 132  | 20         | 25,60 \$ |
| 109721 | 20W 4000K  | 132  | 20         | 27,60 \$ |
| 109158 | 12W 4000K  | 185  | 15         | 35,60 \$ |
| 109163 | 24W 4000K  | 185  | 15         | 38,80 \$ |
| 109165 | 36W 4000K  | 185  | 15         | 41,60 \$ |

IP 40 ⊕ ● 3000K ● 4000K ● 6500K

| Kod No | Özellikler | Ø mm | Koli Adedi | Fiyat    |
|--------|------------|------|------------|----------|
| 109714 | 12W 4000K  | 132  | 20         | 25,60 \$ |
| 109725 | 20W 4000K  | 132  | 20         | 27,60 \$ |
| 109159 | 12W 4000K  | 185  | 15         | 35,60 \$ |
| 109164 | 24W 4000K  | 185  | 15         | 38,80 \$ |
| 109166 | 36W 4000K  | 185  | 15         | 41,60 \$ |

## Tira IP54 Alüminyum Sıva Altı



IP54

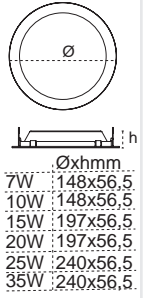

IP 54 ⊕ ● 3000K ● 4000K ● 6500K

| Kod No | Özellikler | Ø mm | Koli Adedi | Fiyat    | Kod No | Özellikler | Ø mm | Koli Adedi | Fiyat    | Kod No | Özellikler | Ø mm | Koli Adedi | Fiyat    |
|--------|------------|------|------------|----------|--------|------------|------|------------|----------|--------|------------|------|------------|----------|
| 107081 | 25W 4000K  | 220  | 10         | 52,30 \$ | 107075 | 15W 4000K  | 185  | 15         | 33,80 \$ | 107069 | 7W 4000K   | 132  | 20         | 28,20 \$ |
| 107084 | 35W 4000K  | 220  | 10         | 59,20 \$ | 107078 | 20W 4000K  | 185  | 15         | 37,50 \$ | 107072 | 10W 4000K  | 132  | 20         | 29,10 \$ |

## Tira Hemyüz Alüminyum Sıva Altı

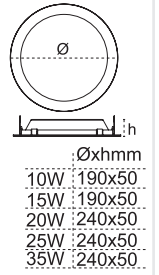

IP 40 ⊕ ● 3000K ● 4000K ● 6500K

| Kod No | Özellikler | Ø mm | Koli Adedi | Fiyat    | Kod No | Özellikler | Ø mm | Koli Adedi | Fiyat    |
|--------|------------|------|------------|----------|--------|------------|------|------------|----------|
| 107086 | 10W 4000K  | 185  | 15         | 30,10 \$ | 107092 | 20W 4000K  | 185  | 10         | 50,10 \$ |
| 107088 | 15W 4000K  | 185  | 15         | 31,10 \$ | 107095 | 25W 4000K  | 185  | 10         | 55,10 \$ |
| 107090 | 20W 4000K  | 185  | 15         | 32,10 \$ | 107097 | 35W 4000K  | 185  | 10         | 60,10 \$ |

## Rina Alüminyum Sıva Üstü

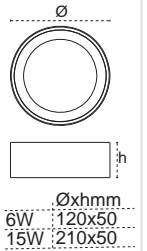

RAL 9005

RAL 9006

RAL 9016

IP 40 ⊕ ● 3000K ● 4000K ● 6500K

| Kod No | Özellikler | Koli Adedi | Fiyat    | Kod No | Özellikler | Koli Adedi | Fiyat    |
|--------|------------|------------|----------|--------|------------|------------|----------|
| 109495 | 6W 4000K   | 16         | 24,10 \$ | 109502 | 15W 4000K  | 16         | 35,80 \$ |

# Sıva Altı Backlight LED Downlight Armatürler

## Tıra Beyaz Ø Sıva Altı

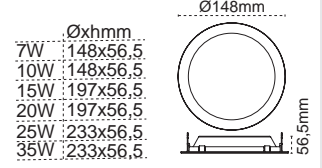

IP 40  ● 3000K ● 4000K ● 6500K

| Kod No | Özellikler | Ø mm | Koli Adedi | Fiyat    | Kod No | Özellikler | Ø mm | Koli Adedi | Fiyat    | Kod No | Özellikler | Ø mm | Koli Adedi | Fiyat    |
|--------|------------|------|------------|----------|--------|------------|------|------------|----------|--------|------------|------|------------|----------|
| 106969 | 20W 4000K  | 220  | 10         | 38,90 \$ | 106943 | 10W 4000K  | 185  | 15         | 24,10 \$ | 106928 | 5W 4000K   | 132  | 20         | 22,30 \$ |
| 106977 | 25W 4000K  | 220  | 10         | 46,30 \$ | 106950 | 15W 4000K  | 185  | 15         | 27,80 \$ | 106934 | 7W 4000K   | 132  | 20         | 23,20 \$ |
| 106985 | 35W 4000K  | 220  | 10         | 53,70 \$ | 106961 | 20W 4000K  | 185  | 15         | 31,50 \$ | 106937 | 10W 4000K  | 132  | 20         | 24,10 \$ |

## Tıra Beyaz Ø<sup>a</sup> Sıva Altı

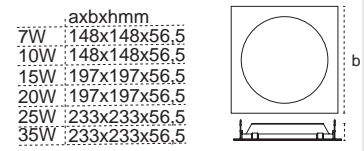

IP 40  ● 3000K ● 4000K ● 6500K

| Kod No | Özellikler | Ø mm | Koli Adedi | Fiyat    | Kod No | Özellikler | Ø mm | Koli Adedi | Fiyat    | Kod No | Özellikler | Ø mm | Koli Adedi | Fiyat    |
|--------|------------|------|------------|----------|--------|------------|------|------------|----------|--------|------------|------|------------|----------|
| 107018 | 20W 4000K  | 220  | 10         | 38,90 \$ | 107003 | 10W 4000K  | 185  | 15         | 24,10 \$ | 106991 | 5W 4000K   | 132  | 20         | 22,30 \$ |
| 107021 | 25W 4000K  | 220  | 10         | 46,30 \$ | 107006 | 15W 4000K  | 185  | 15         | 27,80 \$ | 106994 | 7W 4000K   | 132  | 20         | 23,20 \$ |
| 107025 | 35W 4000K  | 220  | 10         | 53,70 \$ | 107012 | 20W 4000K  | 185  | 15         | 31,50 \$ | 106997 | 10W 4000K  | 132  | 20         | 24,10 \$ |

## Tıra Siyah Ø<sup>a</sup> Sıva Altı

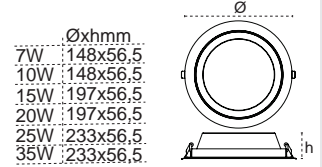

IP 40  ● 3000K ● 4000K ● 6500K

| Kod No | Özellikler | Ø mm | Koli Adedi | Fiyat    | Kod No | Özellikler | Ø mm | Koli Adedi | Fiyat    | Kod No | Özellikler | Ø mm | Koli Adedi | Fiyat    |
|--------|------------|------|------------|----------|--------|------------|------|------------|----------|--------|------------|------|------------|----------|
| 108969 | 20W 4000K  | 220  | 10         | 38,90 \$ | 108633 | 10W 4000K  | 185  | 15         | 24,10 \$ | 108968 | 5W 4000K   | 132  | 20         | 22,30 \$ |
| 107048 | 25W 4000K  | 220  | 10         | 46,30 \$ | 108139 | 15W 4000K  | 185  | 15         | 27,80 \$ | 107044 | 7W 4000K   | 132  | 20         | 23,20 \$ |
| 107049 | 35W 4000K  | 220  | 10         | 53,70 \$ | 107046 | 20W 4000K  | 185  | 15         | 31,50 \$ | 107879 | 10W 4000K  | 132  | 20         | 24,10 \$ |

## Tıra Siyah Ø<sup>a</sup> Sıva Altı

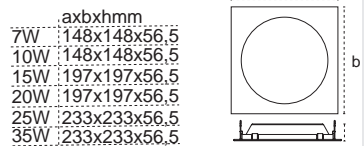

IP 40  ● 3000K ● 4000K ● 6500K

| Kod No | Özellikler | Ø mm | Koli Adedi | Fiyat    | Kod No | Özellikler | Ø mm | Koli Adedi | Fiyat    | Kod No | Özellikler | Ø mm | Koli Adedi | Fiyat    |
|--------|------------|------|------------|----------|--------|------------|------|------------|----------|--------|------------|------|------------|----------|
| 107062 | 20W 4000K  | 220  | 10         | 38,90 \$ | 107056 | 10W 4000K  | 185  | 15         | 24,10 \$ | 107050 | 5W 4000K   | 132  | 20         | 22,30 \$ |
| 107064 | 25W 4000K  | 220  | 10         | 46,30 \$ | 107058 | 15W 4000K  | 185  | 15         | 27,80 \$ | 107052 | 7W 4000K   | 132  | 20         | 23,20 \$ |
| 107066 | 35W 4000K  | 220  | 10         | 53,70 \$ | 107060 | 20W 4000K  | 185  | 15         | 31,50 \$ | 107054 | 10W 4000K  | 132  | 20         | 24,10 \$ |

Rita

## Backlight Konforu Şimdi Ekonomik Fiyatlara!

Ultra Güvenli  
Class II

Entegre Sürücü ile  
Kolay Montaj

Hibrit Gövde  
Alüminyum + Polimer Enjeksiyon

Backlight Teknolojisi ile  
Yüksek Lümen



İçten difüzörlü tasarımı ile  
Kamaşmayı Önler



### Rita 6W

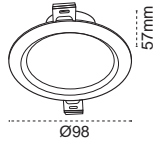

IP 40

| Kod No | Özellikler | Ømm | Koli Adedi | Fiyat   |
|--------|------------|-----|------------|---------|
| 108266 | 6W 4000K   | 85  | 100        | 5,30 \$ |
| 108256 | 6W 6500K   | 85  | 100        | 5,30 \$ |

### Rita 9W

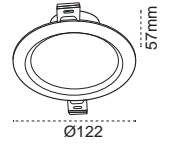

IP 40

| Kod No | Özellikler | Ømm | Koli Adedi | Fiyat   |
|--------|------------|-----|------------|---------|
| 108268 | 9W 4000K   | 100 | 100        | 6,60 \$ |
| 108267 | 9W 6500K   | 100 | 100        | 6,60 \$ |

### Rita 12W

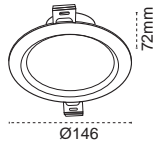

IP 40

| Kod No | Özellikler | Ømm | Koli Adedi | Fiyat   |
|--------|------------|-----|------------|---------|
| 108270 | 12W 4000K  | 125 | 50         | 8,70 \$ |
| 108269 | 12W 6500K  | 125 | 50         | 8,70 \$ |

### Rita 18W

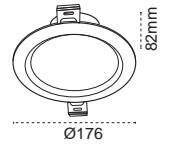

IP 40

| Kod No | Özellikler | Ømm | Koli Adedi | Fiyat    |
|--------|------------|-----|------------|----------|
| 108272 | 18W 4000K  | 155 | 30         | 11,10 \$ |
| 108271 | 18W 6500K  | 155 | 30         | 11,10 \$ |

### Opsiyon Farkları

| Kod No | Özellikler              | Koli Adedi | Fiyat    |
|--------|-------------------------|------------|----------|
| 313117 | Acil Ayd. Kiti (1 saat) | 1          | 26,00 \$ |

# Sıva Üstü ve Sıva Altı Slim LED Downlight Armatürler

## Sirma Sıva Üstü

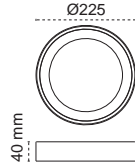

IP 40

| Kod No | Özellikler | Koli Adedi | Fiyat    |
|--------|------------|------------|----------|
| 107999 | 18W 4000K  | 30         | 13,30 \$ |
| 108000 | 18W 6500K  | 30         | 13,30 \$ |
| 108131 | 24W 4000K  | 30         | 27,80 \$ |
| 108132 | 24W 6500K  | 20         | 27,80 \$ |

## Sirma Sıva Üstü

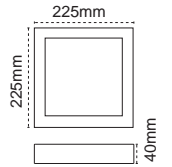

IP 40

| Kod No | Özellikler | Koli Adedi | Fiyat    |
|--------|------------|------------|----------|
| 107997 | 18W 4000K  | 20         | 13,30 \$ |
| 107998 | 18W 6500K  | 20         | 13,30 \$ |
| 108312 | 24W 4000K  | 20         | 27,80 \$ |
| 108310 | 24W 6500K  | 20         | 27,80 \$ |

## Sirma 36W Sıva Üstü

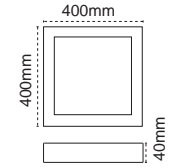

IP 40

| Kod No | Özellikler | Koli Adedi | Fiyat    |
|--------|------------|------------|----------|
| 108151 | 36W 6500K  | 1          | 36,10 \$ |

## Sirma Sıva Altı Yuvarlak

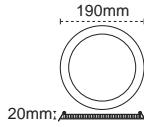

IP 40

| Kod No | Özellikler | Ø mm | Koli Adedi | Fiyat   |
|--------|------------|------|------------|---------|
| 107891 | 3W 3000K   | 75   | 60         | 3,80 \$ |
| 107892 | 3W 4000K   | 75   | 60         | 3,80 \$ |
| 107893 | 3W 6500K   | 75   | 60         | 3,80 \$ |
| 107918 | 6W 3000K   | 105  | 30         | 5,00 \$ |
| 107919 | 6W 4000K   | 105  | 30         | 5,00 \$ |
| 107920 | 6W 6500K   | 105  | 30         | 5,00 \$ |
| 106431 | 15W 3000K  | 175  | 30         | 8,80 \$ |
| 106430 | 15W 4000K  | 175  | 30         | 8,80 \$ |
| 106432 | 15W 6500K  | 175  | 30         | 8,80 \$ |

## Sirma Sıva Altı Kare

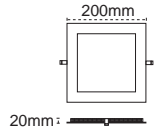

IP 40

| Kod No | Özellikler | ▣ mm    | Koli Adedi | Fiyat    |
|--------|------------|---------|------------|----------|
| 108325 | 15W 6500K  | 170x170 | 30         | 8,80 \$  |
| 108328 | 18W 6500K  | 200x200 | 30         | 9,80 \$  |
| 108327 | 24W 6500K  | 300x300 | 30         | 22,20 \$ |

## Acil Aydınlatma Kiti



| Kod No | Özellikler                             | Koli Adedi | Fiyat    |
|--------|--|------------|----------|
| 313118 | Slim Downlight Acil Ayd. Kiti (1 saat) | 1          | 26,00 \$ |
| 316611 | Slim Downlight Acil Ayd. Kiti (3 saat) | 1          | 30,30 \$ |

## Triac Dim Sürücü Farkları



| Kod No | Özellikler           | Koli Adedi | Fiyat    |
|--------|----------------------|------------|----------|
| 313211 | 12W Triac DIM Driver | 1          | 16,90 \$ |
| 313212 | 15W Triac DIM Driver | 1          | 18,10 \$ |
| 313213 | 18W Triac DIM Driver | 1          | 19,20 \$ |

## Plüton



## Yeni Nesil Plüton ile Renkler Daha Canlı ve Parlak!

 Yönlendirilebilir gövde yapısıyla vurgulamak istediğiniz alanı aydınlatır.

 Kamaşma önleyici difüzörüyle yüksek göz konforu sağlar.

 Dayanıklı metal mandallarıyla montajı kolaydır.

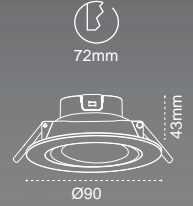

IP 40

| Kod No | Özellikler | Koli Adedi | Fiyat   |
|--------|------------|------------|---------|
| 108454 | 5W 3000K   | 100        | 4,00 \$ |
| 108456 | 5W 6500K   | 100        | 4,00 \$ |

## Sirius



**Kristal**



**Star Sıva Üstü**

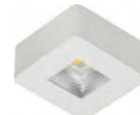
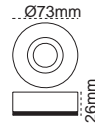

**Star Sıva Üstü**

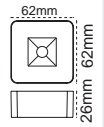

IP 40

| Kod No | Özellikler       | Koli Adedi | Fiyat   |
|--------|------------------|------------|---------|
| 204171 | 2W COB LED 4000K | 20         | 9,10 \$ |

IP 40

| Kod No | Özellikler         | Koli Adedi | Fiyat   |
|--------|--------------------|------------|---------|
| 204175 | 5W COB LED 4000K Ø | 50         | 9,40 \$ |

IP 40

| Kod No | Özellikler       | Koli Adedi | Fiyat   |
|--------|------------------|------------|---------|
| 204174 | 5W COB LED 4000K | 50         | 9,40 \$ |

## Cora 19



**20W**



**2X20W**

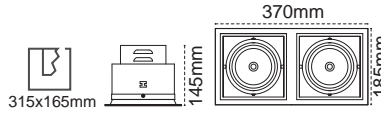

**3X20W**

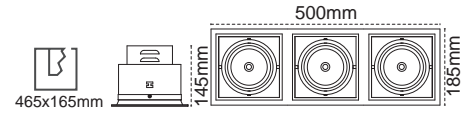

IP 20

| Kod No | Özellikler        | Koli Adedi | Fiyat    |
|--------|-------------------|------------|----------|
| 107900 | 20W COB LED 4000K | 8          | 40,40 \$ |

IP 20

| Kod No | Özellikler          | Koli Adedi | Fiyat    |
|--------|---------------------|------------|----------|
| 107901 | 2X20W COB LED 4000K | 4          | 80,30 \$ |

IP 20

| Kod No | Özellikler          | Koli Adedi | Fiyat     |
|--------|---------------------|------------|-----------|
| 107902 | 3X20W COB LED 4000K | 4          | 119,80 \$ |

## Nira



**Beyaz**



**Siyah**

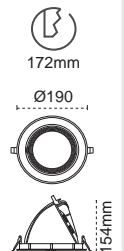

IP 40

| Kod No | Özellikler        | Koli Adedi | Fiyat    |
|--------|-------------------|------------|----------|
| 107904 | 30W COB LED 4000K | 12         | 52,30 \$ |

IP 40

| Kod No | Özellikler        | Koli Adedi | Fiyat    |
|--------|-------------------|------------|----------|
| 108140 | 30W COB LED 4000K | 12         | 52,30 \$ |



## Theta Monofaz



Alüminyum reflektör ve lensli yapısı ile ışığı maksimum odaklar



CRI>80 ile daha canlı renkler



İşığı yönlendiren tasarım(270C° / 360C°)

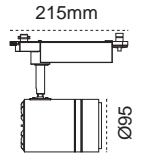

IP 40

| Kod No | Özellikler        | Koli Adedi | Fiyat    |
|--------|-------------------|------------|----------|
| 107982 | 30W COB LED 3000K | 16         | 27,80 \$ |
| 107981 | 30W COB LED 4000K | 16         | 27,80 \$ |

## Seta Monofaz

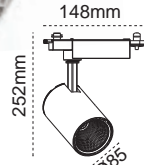

IP 40

| Kod No | Özellikler        | Koli Adedi | Fiyat    |
|--------|-------------------|------------|----------|
| 107907 | 30W COB LED 3000K | 12         | 27,80 \$ |
| 107910 | 30W COB LED 4000K | 12         | 27,80 \$ |

## Lampda Monofaz

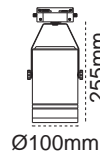

IP 40

| Kod No | Özellikler        | Koli Adedi | Fiyat    |
|--------|-------------------|------------|----------|
| 108010 | 30W COB LED 3000K | 24         | 27,80 \$ |
| 108011 | 30W COB LED 4000K | 24         | 27,80 \$ |

## Estia Monofaz

**Yeni Ürün**

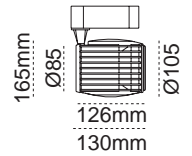

IP 40

| Kod No | Özellikler        | Koli Adedi | Fiyat    |
|--------|-------------------|------------|----------|
| 109479 | 30W COB LED 3000K | 12         | 31,10 \$ |
| 109480 | 30W COB LED 4000K | 12         | 31,10 \$ |

## Monofaz Ray ve Aksesuarları



I Bağlantı



T Bağlantı



L Bağlantı

## Siyah Monofaz Ray ve Aksesuarları

| Kod No | Özellikler                             | Koli Adedi | Fiyat    |
|--------|--|------------|----------|
| 303845 | Tek Fazlı Ray 1 Metre Siyah            | 1          | 5,51 \$  |
| 303846 | Tek Fazlı Ray 2 Metre Siyah            | 1          | 10,97 \$ |
| 303847 | Tek Fazlı Ray 3 Metre Siyah            | 1          | 16,43 \$ |
| 303848 | Tek Fazlı Ray L Bağlantı Parçası Siyah | 1          | 2,26 \$  |
| 303849 | Tek Fazlı Ray T Bağlantı Parçası Siyah | 1          | 2,78 \$  |
| 316066 | Tek Fazlı Ray X Bağlantı Parçası Siyah | 1          | 3,52 \$  |
| 303835 | Tek Fazlı Ray I Bağlantı Parçası Siyah | 1          | 1,73 \$  |
| 316067 | Tek Fazlı Ray Son Parça - Siyah        | 1          | 2,05 \$  |

## Beyaz Monofaz Ray ve Aksesuarları

| Kod No | Özellikler                             | Koli Adedi | Fiyat    |
|--------|--|------------|----------|
| 303839 | Tek Fazlı Ray 1 Metre Beyaz            | 1          | 5,51 \$  |
| 303840 | Tek Fazlı Ray 2 Metre Beyaz            | 1          | 10,97 \$ |
| 303841 | Tek Fazlı Ray 3 Metre Beyaz            | 1          | 16,43 \$ |
| 303842 | Tek Fazlı Ray L Bağlantı Parçası Beyaz | 1          | 2,26 \$  |
| 303843 | Tek Fazlı Ray T Bağlantı Parçası Beyaz | 1          | 2,78 \$  |
| 316068 | Tek Fazlı Ray X Bağlantı Parçası Beyaz | 1          | 3,52 \$  |
| 303844 | Tek Fazlı Ray I Bağlantı Parçası Beyaz | 1          | 1,73 \$  |
| 316069 | Tek Fazlı Ray Son Parça - Beyaz        | 1          | 2,05 \$  |

**Ayna Üstü ve Duvar Apliği Otto** **Yeni Ürün**



625mm  
40mm  
135mm

IP 40 4000K 6500K

| Kod No | Özellikler                | Koli Adedi | Fiyat    |
|--------|---------------------------|------------|----------|
| 109539 | 10W 4000K LED             | 10         | 45,80 \$ |
| 109540 | 9W 6500K LED Tube Lambalı | 10         | 28,70 \$ |

**Ayna Üstü ve Duvar Apliği Vogel** **Yeni Ürün**



axbxcmm  
2x9W : 650x100x70  
20W : 1145x100x70

IP 40 4000K 6500K

| Kod No | Özellikler                  | Koli Adedi | Fiyat    |
|--------|-----------------------------|------------|----------|
| 109541 | 20W 4000K LED               | 10         | 42,10 \$ |
| 109542 | 2x9W 6500K LED Tube Lambalı | 10         | 19,00 \$ |

**Tablo Apliği Guardi** **Alüminyum Gövde**



Çift Kademeli Anahtarlı

50mm  
165mm  
405mm

IP 40

| Kod No | Özellikler | Koli Adedi | Fiyat    |
|--------|------------|------------|----------|
| 204551 | 7W 4000K   | 10         | 19,70 \$ |

**Tablo Apliği Da Vinci** **Alüminyum Gövde**



171mm  
510mm  
170mm

IP 40

| Kod No | Özellikler | Koli Adedi | Fiyat    |
|--------|------------|------------|----------|
| 204544 | 5W 4000K   | 10         | 29,00 \$ |

**Anahtarlı Duvar Apliği Dali** **Alüminyum Gövde**



Anahtarlı

580mm  
29mm  
85mm

IP 40

| Kod No | Özellikler | Koli Adedi | Fiyat    |
|--------|------------|------------|----------|
| 204547 | 6W 4000K   | 12         | 33,00 \$ |

**Ayna Üstü ve Duvar Apliği Vien** **Yeni Ürün** **Alüminyum Gövde**





Anahtarlı

59mm  
25mm  
64mm

IP 40

| Kod No | Özellikler | Koli Adedi | Fiyat    |
|--------|------------|------------|----------|
| 204569 | 3W 4000K   | 30         | 15,50 \$ |

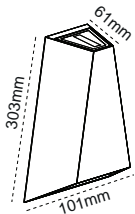

**Cono** **Yeni Ürün**





IP 20  ● 4000K ● 6500K

| Kod No | Özellikler | Koli Adedi | Fiyat    |
|--------|------------|------------|----------|
| 106049 | 6W 3000K   | 6          | 27,80 \$ |

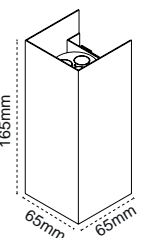
**Rodin** **Yeni Ürün**





IP 20  ● 4000K ● 6500K

| Kod No | Özellikler   | Koli Adedi | Fiyat    |
|--------|--------------|------------|----------|
| 109764 | 2xGu10 Duylu | 12         | 10,20 \$ |

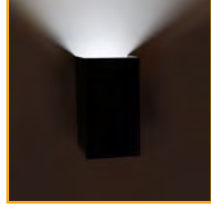
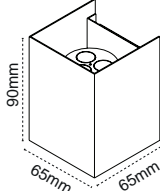

**Lorca** **Yeni Ürün**





IP 20  ● 4000K ● 6500K

| Kod No | Özellikler   | Koli Adedi | Fiyat   |
|--------|--------------|------------|---------|
| 109765 | 2xGu10 Duylu | 12         | 8,80 \$ |

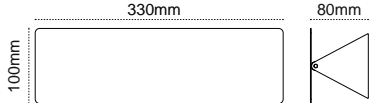

**Quinn** **Yeni Ürün**



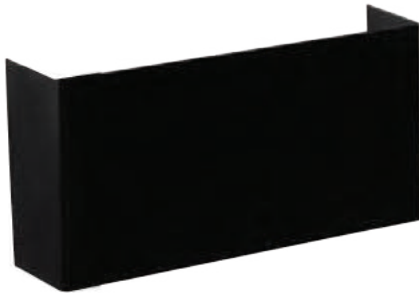

IP 20  ● 4000K ● 6500K

| Kod No | Özellikler | Koli Adedi | Fiyat    |
|--------|------------|------------|----------|
| 109761 | 10W 4000K  | 12         | 38,30 \$ |

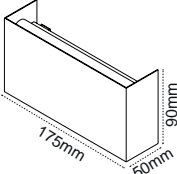

**Landi** **Yeni Ürün**





IP 20  ● 4000K ● 6500K

| Kod No | Özellikler | Koli Adedi | Fiyat    |
|--------|------------|------------|----------|
| 109763 | 7W 4000K   | 12         | 37,50 \$ |

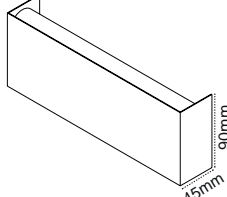
**Diaz** **Yeni Ürün**

IP 20  ● 4000K ● 6500K

| Kod No | Özellikler | Koli Adedi | Fiyat    |
|--------|------------|------------|----------|
| 109762 | 10W 4000K  | 12         | 42,90 \$ |

### Punto



Sensör

Ø350  
74mm

IP 40 4000K 6500K

| Kod No | Özellikler                      | Koli Adedi | Fiyat    |
|--------|---------------------------------|------------|----------|
| 107945 | 24W Yuvarlak 6500K              | 10         | 26,20 \$ |
| 108772 | 24W Yuvarlak 6500K Radar Sensör | 10         | 41,10 \$ |

### Picto



Ø350  
74mm

IP 40 4000K 6500K

| Kod No | Özellikler         | Koli Adedi | Fiyat    |
|--------|--------------------|------------|----------|
| 107960 | 24W Yuvarlak 6500K | 10         | 24,80 \$ |

### Punto Dinamik Beyaz



Ø350  
74mm

Anahtar 1. Kademe 2. Kademe 3. Kademe

IP 40 3000K 4000K 6500K

| Kod No | Özellikler                   | Koli Adedi | Fiyat    |
|--------|------------------------------|------------|----------|
| 107946 | 2x24W Yuvarlak Dinamik Beyaz | 10         | 26,20 \$ |

### Picto Dinamik Beyaz



Ø350  
74mm

Anahtar 1. Kademe 2. Kademe 3. Kademe

IP 40 3000K 4000K 6500K

| Kod No | Özellikler                   | Koli Adedi | Fiyat    |
|--------|------------------------------|------------|----------|
| 107961 | 2x24W Yuvarlak Dinamik Beyaz | 10         | 24,80 \$ |

### Punto



Sensör

350mm  
350mm  
74mm

IP 40 4000K 6500K

| Kod No | Özellikler                  | Koli Adedi | Fiyat    |
|--------|-----------------------------|------------|----------|
| 107948 | 24W Kare 6500K              | 10         | 26,20 \$ |
| 108773 | 24W Kare 6500K Radar Sensör | 10         | 41,10 \$ |

### Picto



350mm  
350mm  
74mm

IP 40 4000K 6500K

| Kod No | Özellikler     | Koli Adedi | Fiyat    |
|--------|----------------|------------|----------|
| 107963 | 24W Kare 6500K | 10         | 24,80 \$ |

### Punto Dinamik Beyaz



350mm  
350mm  
74mm

Anahtar 1. Kademe 2. Kademe 3. Kademe

IP 40 3000K 4000K 6500K

| Kod No | Özellikler               | Koli Adedi | Fiyat    |
|--------|--------------------------|------------|----------|
| 107949 | 2x24W Kare Dinamik Beyaz | 10         | 26,20 \$ |

### Picto Dinamik Beyaz



350mm  
350mm  
74mm

Anahtar 1. Kademe 2. Kademe 3. Kademe

IP 40 3000K 4000K 6500K

| Kod No | Özellikler               | Koli Adedi | Fiyat    |
|--------|--------------------------|------------|----------|
| 107964 | 2x24W Kare Dinamik Beyaz | 10         | 24,80 \$ |

## Pio Ø



Ø350mm

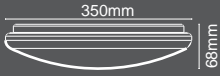

350mm  
68mm



Ø250mm



250mm  
68mm

IP 40 ☺ ● 4000K ● 6500K

| Kod No | Özellikler          | Koli Adedi | Fiyat    |
|--------|---------------------|------------|----------|
| 107950 | 24W 4000K           | 10         | 22,90 \$ |
| 107951 | 24W 6500K           | 10         | 22,90 \$ |
| 107952 | 2x24W Dinamik Beyaz | 10         | 22,90 \$ |

| Kod No | Özellikler | Koli Adedi | Fiyat    |
|--------|------------|------------|----------|
| 105855 | 16W 4000K  | 10         | 15,50 \$ |
| 105395 | 16W 6500K  | 10         | 15,50 \$ |

## Pio ↗



↗ 350mm

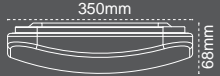

350mm  
68mm



↗ 250mm



250mm  
68mm

IP 40 ☺ ● 4000K ● 6500K

| Kod No | Özellikler          | Koli Adedi | Fiyat    |
|--------|---------------------|------------|----------|
| 107954 | 24W 6500K           | 10         | 22,90 \$ |
| 107956 | 2x24W Dinamik Beyaz | 10         | 22,90 \$ |

| Kod No | Özellikler | Koli Adedi | Fiyat    |
|--------|------------|------------|----------|
| 105393 | 16W 6500K  | 10         | 15,50 \$ |

## İlkbahar



Ø410mm



Ø340  
70mm

IP 40 ☺

| Kod No | Özellikler | Koli Adedi | Fiyat    |
|--------|------------|------------|----------|
| 105387 | 23W 6500K  | 5          | 30,50 \$ |

## Cemre



Ø340mm



Ø410  
72mm

IP 40 ☺

| Kod No | Özellikler | Koli Adedi | Fiyat    |
|--------|------------|------------|----------|
| 105386 | 23W 6500K  | 10         | 21,30 \$ |

## Yenice

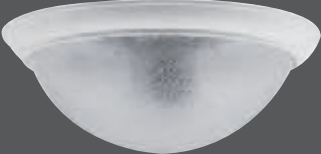

Ø235mm

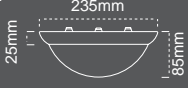

235mm  
25mm  
85mm

IP 40 ☺

| Kod No | Özellikler | Koli Adedi | Fiyat   |
|--------|------------|------------|---------|
| 104353 | Yenice E27 | 24         | 4,30 \$ |

## Samsun



↗232mm



232mm  
32mm  
152mm

IP 40 ☺

| Kod No | Özellikler | Koli Adedi | Fiyat   |
|--------|------------|------------|---------|
| 104356 | Samsun E27 | 24         | 4,60 \$ |

## Sipahi



Ø232mm



232mm  
32mm  
152mm

IP 40 ☺

| Kod No | Özellikler | Koli Adedi | Fiyat   |
|--------|------------|------------|---------|
| 104351 | Sipahi E27 | 20         | 4,60 \$ |

# Pelsan Dış Mekan Tavan / Duvar Armatürleri

## IP44 Oval Kafes Alüminyum Enjeksiyon



- Alüminyum Enjeksiyon Gövde
- IP44 Harici Armatür
- E27 Duylu

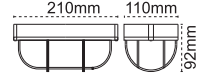

IP 44

| Kod No | Özellikler | Koli Adedi | Fiyat   |
|--------|------------|------------|---------|
| 204487 | E27 Duylu  | 18         | 9,90 \$ |

## Berk IP65



IP 65

| Kod No | Özellikler | Koli Adedi | Fiyat    |
|--------|------------|------------|----------|
| 109208 | 20W 6500K  | 10         | 17,80 \$ |

## Akay IP65

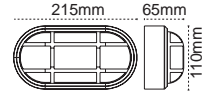

IP 65

| Kod No | Özellikler | Koli Adedi | Fiyat    |
|--------|------------|------------|----------|
| 109207 | 15W 6500K  | 10         | 15,60 \$ |

## Havana Ø Çift Işık Gri/Kırmızı

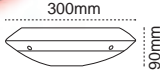
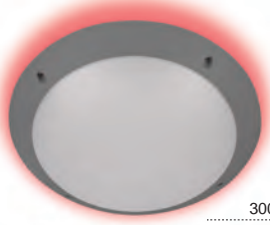

IP 66

| Kod No | Özellikler | Koli Adedi | Fiyat    |
|--------|------------|------------|----------|
| 105093 | E27        | 8          | 16,90 \$ |
| 108464 | 2XE27      | 8          | 17,90 \$ |

## Havana Ø Çift Işık Gri/Turuncu

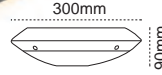
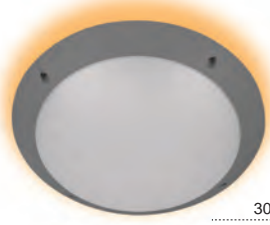

IP 66

| Kod No | Özellikler | Koli Adedi | Fiyat    |
|--------|------------|------------|----------|
| 105095 | E27        | 8          | 16,90 \$ |
| 108466 | 2XE27      | 8          | 17,90 \$ |

## Havana Ø Çift Işık Gri/Mavi

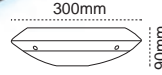
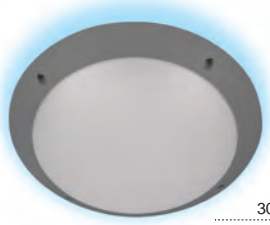

IP 66

| Kod No | Özellikler | Koli Adedi | Fiyat    |
|--------|------------|------------|----------|
| 105094 | E27        | 8          | 16,90 \$ |
| 108465 | 2XE27      | 8          | 17,90 \$ |

## Havana Ø Çift Işık Gri/Kırmızı

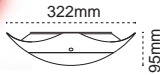
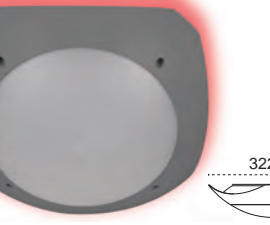

IP 66

| Kod No | Özellikler | Koli Adedi | Fiyat    |
|--------|------------|------------|----------|
| 108467 | E27        | 8          | 16,90 \$ |
| 108358 | 2XE27      | 8          | 17,90 \$ |

## Havana Ø Çift Işık Gri/Turuncu

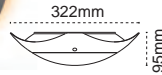
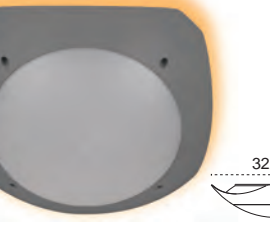

IP 66

| Kod No | Özellikler | Koli Adedi | Fiyat    |
|--------|------------|------------|----------|
| 108469 | E27        | 8          | 16,90 \$ |
| 108360 | 2XE27      | 8          | 17,90 \$ |

## Havana Ø Çift Işık Gri/Mavi

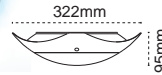
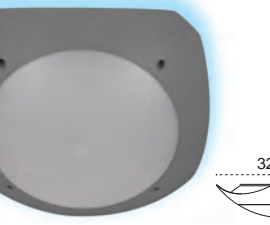

IP 66

| Kod No | Özellikler | Koli Adedi | Fiyat    |
|--------|------------|------------|----------|
| 108468 | E27        | 8          | 16,90 \$ |
| 108359 | 2XE27      | 8          | 17,90 \$ |



Çift Işık Opsiyonel



## IP66 Toz ve Su Almaz

- Pelsan Havana tavan armatürü IP66 koruma sınıfı ile çevre şartlarından etkilenmez.
- Darbe dayanımı yüksektir. Kırılmaz.
- E27, LED, LED radar sensörlü, LED acil aydınlatma kitli opsiyonları vardır.
- Paslanmaz vida ve UV ışınları ile sararmaz opal cama sahiptir.

**Havana Ø IP66** 

 Acil  
 Sensör





300mm  
90mm

IP 66   

| Kod No | Özellikler                      | Koli Adedi | Fiyat    |
|--------|---------------------------------|------------|----------|
| 105092 | E27                             | 8          | 14,80 \$ |
| 105124 | 2XE27                           | 8          | 15,80 \$ |
| 105101 | 15W 6500K                       | 8          | 21,40 \$ |
| 105118 | 15W 6500K Sensör                | 8          | 50,70 \$ |
| 105109 | 15W 6500K Acil Ayd Kit          | 8          | 50,70 \$ |
| 109048 | 15W 6500K Sensör + Acil Ayd Kit | 8          | 84,40 \$ |

**Havana Ø IP66** 

 Acil  
 Sensör



300mm  
90mm

IP 66   

| Kod No | Özellikler                      | Koli Adedi | Fiyat    |
|--------|---------------------------------|------------|----------|
| 105090 | E27                             | 8          | 14,80 \$ |
| 105122 | 2XE27                           | 8          | 15,80 \$ |
| 105098 | 15W 6500K                       | 8          | 21,40 \$ |
| 105115 | 15W 6500K Sensör                | 8          | 50,70 \$ |
| 105106 | 15W 6500K Acil Ayd Kit          | 8          | 50,70 \$ |
| 109047 | 15W 6500K Sensör + Acil Ayd Kit | 8          | 84,40 \$ |

**Havana Ø IP66** 

 Acil  
 Sensör



300mm  
90mm

IP 66   

| Kod No | Özellikler                      | Koli Adedi | Fiyat    |
|--------|---------------------------------|------------|----------|
| 105091 | E27                             | 8          | 14,80 \$ |
| 105123 | 2XE27                           | 8          | 15,80 \$ |
| 105104 | 15W 6500K                       | 8          | 21,40 \$ |
| 105121 | 15W 6500K Sensör                | 8          | 50,70 \$ |
| 105112 | 15W 6500K Acil Ayd Kit          | 8          | 50,70 \$ |
| 109049 | 15W 6500K Sensör + Acil Ayd Kit | 8          | 84,40 \$ |

**Havana Ø IP66** 

 Acil  
 Sensör



322mm  
95mm

IP 66   

| Kod No | Özellikler                      | Koli Adedi | Fiyat    |
|--------|---------------------------------|------------|----------|
| 108367 | E27                             | 8          | 14,80 \$ |
| 108368 | 2XE27                           | 8          | 15,80 \$ |
| 108277 | 15W 6500K                       | 8          | 21,40 \$ |
| 108369 | 15W 6500K Sensör                | 8          | 50,70 \$ |
| 108370 | 15W 6500K Acil Ayd Kit          | 8          | 50,70 \$ |
| 109051 | 15W 6500K Sensör + Acil Ayd Kit | 8          | 84,40 \$ |

**Havana Ø IP66** 

 Acil  
 Sensör



322mm  
95mm

IP 66   

| Kod No | Özellikler                      | Koli Adedi | Fiyat    |
|--------|---------------------------------|------------|----------|
| 108273 | E27                             | 8          | 14,80 \$ |
| 108279 | 2XE27                           | 8          | 15,80 \$ |
| 108276 | 15W 6500K                       | 8          | 21,40 \$ |
| 108361 | 15W 6500K Sensör                | 8          | 50,70 \$ |
| 108362 | 15W 6500K Acil Ayd Kit          | 8          | 50,70 \$ |
| 109050 | 15W 6500K Sensör + Acil Ayd Kit | 8          | 84,40 \$ |

**Havana Ø IP66** 

 Acil  
 Sensör



322mm  
95mm

IP 66   

| Kod No | Özellikler                      | Koli Adedi | Fiyat    |
|--------|---------------------------------|------------|----------|
| 108363 | E27                             | 8          | 14,80 \$ |
| 108364 | 2XE27                           | 8          | 15,80 \$ |
| 108278 | 15W 6500K                       | 8          | 21,40 \$ |
| 108365 | 15W 6500K Sensör                | 8          | 50,70 \$ |
| 108366 | 15W 6500K Acil Ayd Kit          | 8          | 50,70 \$ |
| 109052 | 15W 6500K Sensör + Acil Ayd Kit | 8          | 84,40 \$ |

### Sense Sensörlü (2xE27)



Sensör  
Duy

300mm  
105mm

IP 20

| Kod No | Özellikler     | Koli Adedi | Fiyat    |
|--------|----------------|------------|----------|
| 104359 | 2xE27 Sensörlü | 10         | 12,90 \$ |

### Sensörlü LED'li Buzlu Difüzör



Sensör  
LED

300mm  
105mm

IP 20 4000K 6500K

| Kod No | Özellikler            | Koli Adedi | Fiyat    |
|--------|-----------------------|------------|----------|
| 109586 | 6W LED 6500K Sensörlü | 10         | 20,00 \$ |

### Sense Tavan (2xE27)



Duy

300mm  
105mm

IP 20

| Kod No | Özellikler | Koli Adedi | Fiyat    |
|--------|------------|------------|----------|
| 104357 | 2xE27      | 10         | 12,40 \$ |

### Acil Sensörlü LED'li Buzlu Difüzör



Sensör  
Acil  
LED

300mm  
105mm

IP 20 4000K 6500K

| Kod No | Özellikler                        | Koli Adedi | Fiyat    |
|--------|-----------------------------------|------------|----------|
| 109597 | 8W LED 6500K Sensörlü + Acil Ayd. | 10         | 36,40 \$ |

### Acil Sensörlü (2xE27)



Sensör  
Acil  
Duy

300mm  
105mm

IP 20

| Kod No | Özellikler                 | Koli Adedi | Fiyat    |
|--------|----------------------------|------------|----------|
| 104367 | 2xE27 Sensörlü + Acil Ayd. | 10         | 18,30 \$ |

### Koridor Fonksiyonlu LED Tube



Sensör

Çift Taraftan Bağlantı

IP 20

| Kod No | Özellikler             | Koli Adedi | Fiyat    |
|--------|------------------------|------------|----------|
| 315115 | 18W Sensör 6500K 120cm | 25         | 16,65 \$ |

### IP65 Sensör Kutusu



134mm



Dış mekanlarda kolaylıkla sensör kullanmanızı sağlar.

IP 65

| Kod No | Özellikler         | Koli Adedi | Fiyat    |
|--------|--------------------|------------|----------|
| 314735 | IP65 Sensör Kutusu | 50         | 10,10 \$ |

### Dört Yönlü Hareket Sensörü



4 m  
8 m

Özellikle kör nokta algılamaları için ayarlanabilir başlığı sayesinde hassas algılama yapar.

IP 20

| Kod No | Özellikler                 | Koli Adedi | Fiyat    |
|--------|----------------------------|------------|----------|
| 314729 | Dört Yönlü Hareket Sensörü | 100        | 13,40 \$ |



## IP44 Sensörlü Aplik Işıközü

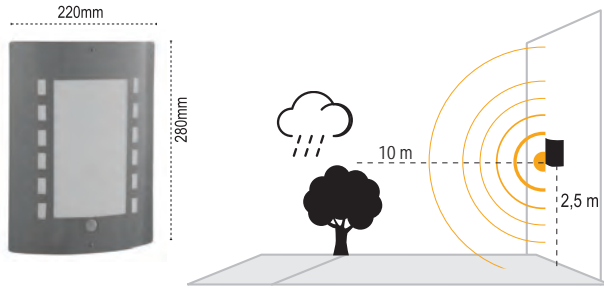

IP 44

| Kod No | Özellikler                  | Koli Adedi | Fiyat    |
|--------|-----------------------------|------------|----------|
| 109297 | Işıközü Sensörlü E27 Duyulu | 10         | 40,00 \$ |

## IP54 Sensörlü Aplik Mova

**Yeni Ürün**

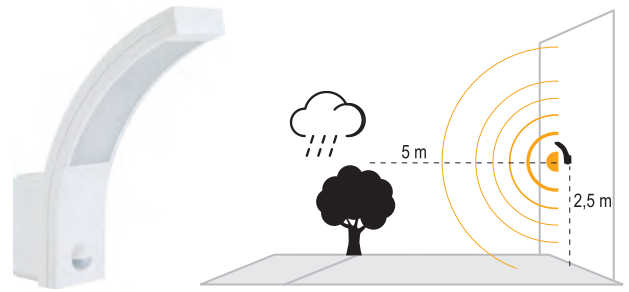

IP 54

| Kod No | Özellikler               | Koli Adedi | Fiyat    |
|--------|--------------------------|------------|----------|
| 109228 | 10W Sensörlü Aplik 6500K | 10         | 28,50 \$ |

## Radarsensörlü İç Mekan Tavan Armatürleri

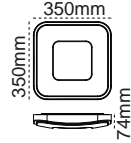

IP 40

| Kod No | Özellikler               | Koli Adedi | Fiyat    |
|--------|--------------------------|------------|----------|
| 108773 | 24W 6500K Radar Sensörlü | 10         | 41,10 \$ |

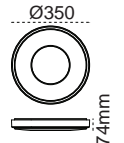

IP 40

| Kod No | Özellikler                   | Koli Adedi | Fiyat    |
|--------|------------------------------|------------|----------|
| 108772 | 24W LED 6500K Radar Sensörlü | 10         | 41,10 \$ |



## IP66 Havana Radarsensörlü + Acil Aydınlatma Kitli

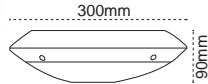

IP 66

3000K 4000K 6500K

| Kod No | Özellikler                              | Koli Adedi | Fiyat    |
|--------|---|------------|----------|
| 105115 | 15W LED 6500K Radar Sensörlü            | 8          | 50,70 \$ |
| 109047 | 15W LED 6500K Radar Sensörlü+ Acil Ayd. | 8          | 84,40 \$ |

## Dekoled 30x30 Sıva Üstü

**Yeni Ürün**

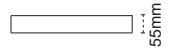

IP 40

3000K 4000K 6500K

| Kod No | Özellikler                                       | Koli Adedi | Fiyat    |
|--------|--|------------|----------|
| 108780 | 12W 30x30 S.Ü. 6500K Radar Sens.                 | 5          | 47,20 \$ |
| 109086 | 12W 30x30 S.Ü. 6500K Radar Sens. + Acil Ayd. Kit | 5          | 73,20 \$ |

## Sensörlü Projektör

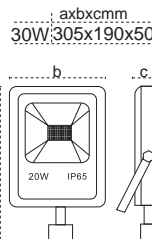

IP 65

| Kod No | Özellikler         | Koli Adedi | Fiyat    |
|--------|--------------------|------------|----------|
| 107118 | 30W Sensörlü 6500K | 10         | 30,10 \$ |

## E27 Duyulu Sensör Kolaysense

**Yeni Ürün**

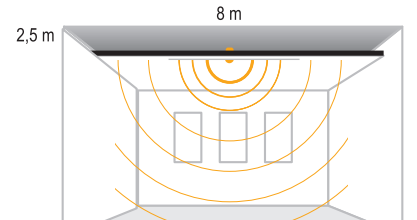

Zaman ve Lux ayarlama özelliği ile sıva üstü uygulamalar için ideal çözüm

IP 20

| Kod No | Özellikler        | Koli Adedi | Fiyat    |
|--------|-------------------|------------|----------|
| 109227 | E27 Duyulu Sensör | 50         | 10,10 \$ |

### 360° Hareket Sensörü

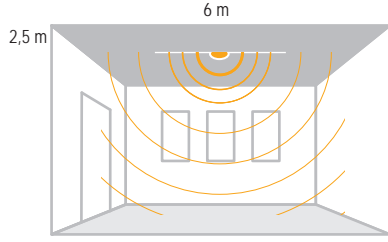

3 gözlü teknoloji ile çok geniş bir alanı tarayarak her yönden algılamaya yapar.

IP 20

| Kod No | Özellikler                 | Koli Adedi | Fiyat   |
|--------|----------------------------|------------|---------|
| 314720 | 360 Derece Hareket Sensörü | 50         | 8,80 \$ |

### 180° Hareket Sensörü

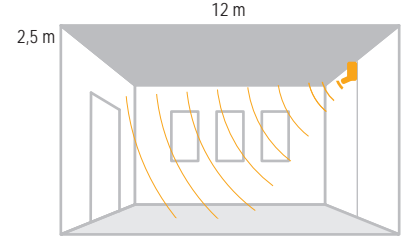

IP 20

| Kod No | Özellikler                 | Koli Adedi | Fiyat   |
|--------|----------------------------|------------|---------|
| 314717 | 180 Derece Hareket Sensörü | 50         | 8,20 \$ |

### Varlık Sensörü

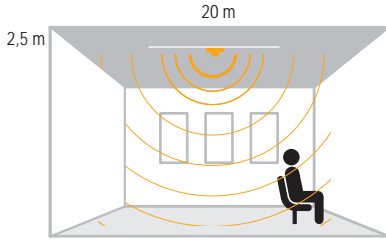

Ortamdaki kişiye duyarlı olarak aydınlatma kontrolü sağlar.

IP 20

| Kod No | Özellikler     | Koli Adedi | Fiyat    |
|--------|----------------|------------|----------|
| 314733 | Varlık Sensörü | 50         | 22,30 \$ |

### Mini Hareket Sensörü

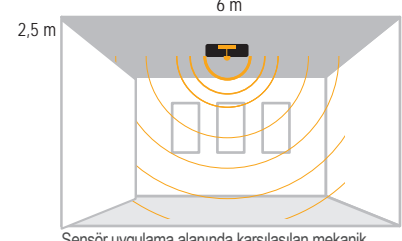

Sensör uygulama alanında karşılaşılan mekanik yerleşim sorunlarını gidemek için pratik kullanım sağlar.

IP 20

| Kod No | Özellikler           | Koli Adedi | Fiyat   |
|--------|----------------------|------------|---------|
| 314732 | Mini Hareket Sensörü | 100        | 8,20 \$ |

### Radar Sensör

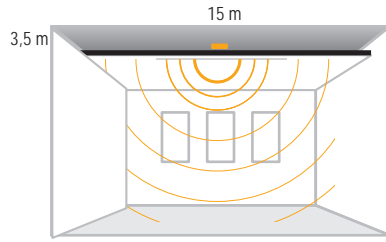

Sıva altı, gizli, armatür içi ve dışı uygulamalarda en iyi çözüm.

IP 20

| Kod No | Özellikler   | Koli Adedi | Fiyat    |
|--------|--------------|------------|----------|
| 314725 | Radar Sensör | 100        | 13,70 \$ |

### Sıva Altı Tavan Sensör

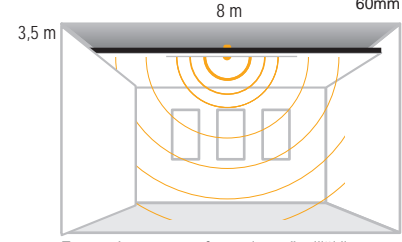

Zaman, Lux ve mesafe ayarlama özelliği ile sıva altı uygulamalar için ideal çözüm

IP 20

| Kod No | Özellikler             | Koli Adedi | Fiyat    |
|--------|------------------------|------------|----------|
| 314726 | Sıva Altı Tavan Sensör | 50         | 10,00 \$ |

### Fotosel

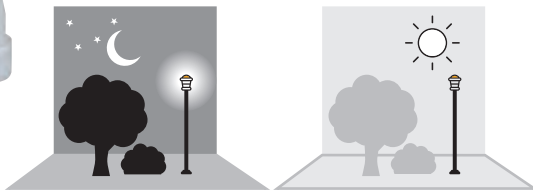

Gece gündüz farkını algılayarak dış mekan aydınlatmalarında kontrol sağlar.

IP 54

| Kod No | Özellikler | Koli Adedi | Fiyat   |
|--------|------------|------------|---------|
| 314738 | Fotosel    | 100        | 5,30 \$ |

### Yüksek Tavan Sensörü

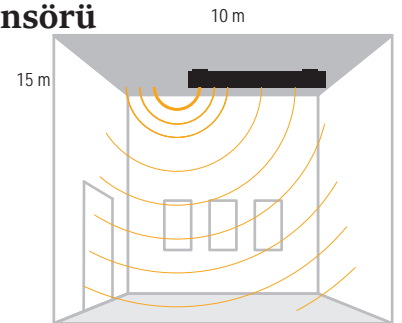

4-15 mt arası yüksekliklerde hassas algılamaya yapan yüksek tavan sensörü ile Lux, mesafe ve zaman ayarı yapılabilir.

IP 20

| Kod No | Özellikler           | Koli Adedi | Fiyat    |
|--------|----------------------|------------|----------|
| 314730 | Yüksek Tavan Sensörü | 50         | 31,70 \$ |

## Emergency Spot



2x3W

261mm  
59mm

IP 40



2x5W

280mm  
279mm

IP 40



2x10W

286mm  
299mm

IP 40

| Kod No | Özellikler         | Koli Adedi | Fiyat     |
|--------|--------------------|------------|-----------|
| 203911 | 2x3W LEDli 6 Saat  | 10         | 34,00 \$  |
| 203913 | 2x5W LEDli 4 Saat  | 8          | 66,50 \$  |
| 203907 | 2x10W LEDli 6 Saat | 8          | 121,80 \$ |

## Emergency Spot

Yeni Ürün



2x5W

IP 40 4000K 6500K



2x10W

IP 40 4000K 6500K

axbxcmm  
2x5W :275x340x80  
2x10W :325x340x80



| Kod No | Özellikler         | Koli Adedi | Fiyat     |
|--------|--------------------|------------|-----------|
| 109781 | 2x5W 3 Saat 4000K  | 4          | 75,00 \$  |
| 109780 | 2x10W 3 Saat 4000K | 4          | 130,20 \$ |

## İşıldaklar



203mm  
55mm  
29mm

IP 40



342mm  
55mm  
29mm

IP 40



482mm  
55mm  
29mm

IP 40

| Kod No | Özellikler          | Koli Adedi | Fiyat    |
|--------|---------------------|------------|----------|
| 204619 | 30 LEDli İşıldak    | 40         | 8,80 \$  |
| 204620 | 40-60 LEDli İşıldak | 24         | 15,20 \$ |
| 204623 | 90 LEDli İşıldak    | 20         | 24,80 \$ |

### Acil LED Lamba



Ø60  
113mm

3 Saat  
Acil Durum Aydınlatma

### Acil Aydınlatma Spotu (3 Saat)



Ø110  
20mm

3 Saat  
Acil Durum Aydınlatma

### Acil Kitli LED Tube



Çift Taraftan Bağlantı

15 Saat  
Acil Durum Aydınlatma

| Kod No | Özellikler           | Koli Adedi | Fiyat    |
|--------|----------------------|------------|----------|
| 315107 | 9W 6500K E27         | 50         | 7,00 \$  |
| 204465 | 3W 6500K (2'li)      | 20         | 33,80 \$ |
| 315116 | 18W Acil 6500K 120cm | 25         | 17,50 \$ |



Exiled Sıva Altı



Exiled



Alüminyum Gövde



3 Saat Deşarj Süresi



Test Butonu



Şarj Göstergesi



AC / DC Çalışma

**Çift Yön**  
Exiled (3 Saat) sabit etiketli

IP 20

360mm 24mm  
150mm

| Kod No | Özellikler  | Koli Adedi | Fiyat    |
|--------|-------------|------------|----------|
| 203888 | Çift Yön 3W | 20         | 10,20 \$ |

**Çift Yön**  
Exiled (3 Saat) sabit etiketli

IP 20

360mm 24mm  
150mm

| Kod No | Özellikler  | Koli Adedi | Fiyat    |
|--------|-------------|------------|----------|
| 203889 | Çift Yön 3W | 20         | 10,20 \$ |

**Çift Yön**  
Exiled (3 Saat) sabit etiketli

IP 20

360mm 24mm  
150mm

| Kod No | Özellikler  | Koli Adedi | Fiyat    |
|--------|-------------|------------|----------|
| 203887 | Çift Yön 3W | 20         | 10,20 \$ |

**Tek Yön**  
Exiled (3 Saat) sabit etiketli

IP 20

360mm 24mm  
150mm

| Kod No | Özellikler | Koli Adedi | Fiyat    |
|--------|------------|------------|----------|
| 203891 | Tek Yön 3W | 20         | 10,20 \$ |

**Çift Yön**  
Exiled (3 Saat) sabit etiketli

IP 20

360mm 24mm  
150mm

| Kod No | Özellikler  | Koli Adedi | Fiyat    |
|--------|-------------|------------|----------|
| 203885 | Çift Yön 3W | 20         | 10,20 \$ |

**Çift Yön**  
Exiled (3 Saat) sabit etiketli

IP 20

360mm 24mm  
150mm

| Kod No | Özellikler  | Koli Adedi | Fiyat    |
|--------|-------------|------------|----------|
| 203890 | Çift Yön 3W | 20         | 10,20 \$ |

### Opsiyon Farkı

| Özellikler              | Fiyat    |
|-------------------------|----------|
| Sıva Altı Fiyat Farkı   | 10,90 \$ |
| Özel Etiket Fiyat Farkı | 6,20 \$  |

## IP65 Acil Yönlendirme Armatürü Rausled (3 Saat)

**Yeni Ürün**

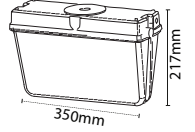

IP 65  4000K  6500K

\* Etiket hediyeledir. Farklı yönlerde kullanılabilir.

| Kod No | Özellikler         | Koli Adedi | Fiyat    |
|--------|--------------------|------------|----------|
| 109387 | 3W 6500K Sıva Üstü | 10         | 56,00 \$ |

## IP65 Acil Aydınlatma ve Yönlendirme Armatürü Ausled (3 Saat)

Sıva Üstü



Sıva Altı

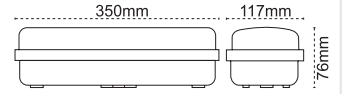
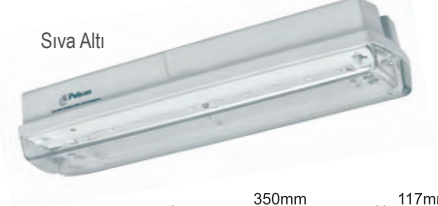

Dört Farklı Yönlendirme Etiketi Hediyeledir

IP 65  4000K  6500K

IP 65  4000K  6500K

| Kod No | Özellikler         | Koli Adedi | Fiyat    | Kod No | Özellikler             | Koli Adedi | Fiyat    |
|--------|--------------------|------------|----------|--------|------------------------|------------|----------|
| 108390 | 5W 6500K Sıva Üstü | 12         | 45,60 \$ | 108390 | 5W 6500K Sıva Üstü     | 12         | 45,60 \$ |
|        |                    |            |          | 315895 | Sıva Altı Yayı (ikili) | 1          | 2,70 \$  |

## Acil Yönlendirme Armatürü Vialled (3 Saat)



Sıva Altı

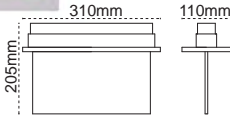

Mafsallı

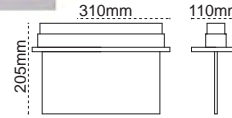

Sarkıt

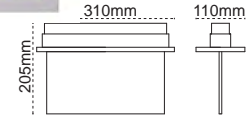

IP 40 

IP 40 

IP 40 

| Kod No | Özellikler       | Koli Adedi | Fiyat    | Kod No | Özellikler           | Koli Adedi | Fiyat    | Kod No | Özellikler         | Koli Adedi | Fiyat    |
|--------|------------------|------------|----------|--------|----------------------|------------|----------|--------|--------------------|------------|----------|
| 201064 | S.A. Tek Yön 3W  | 10         | 27,80 \$ | 200944 | Mafsallı Tek Yön 3W  | 10         | 27,80 \$ | 201136 | Sarkıt Tek Yön 3W  | 10         | 27,80 \$ |
| 201110 | S.A. Çift Yön 3W | 10         | 27,80 \$ | 201013 | Mafsallı Çift Yön 3W | 10         | 27,80 \$ | 201165 | Sarkıt Çift Yön 3W | 10         | 27,80 \$ |

## Sonsuz Etiket Opsiyonu!

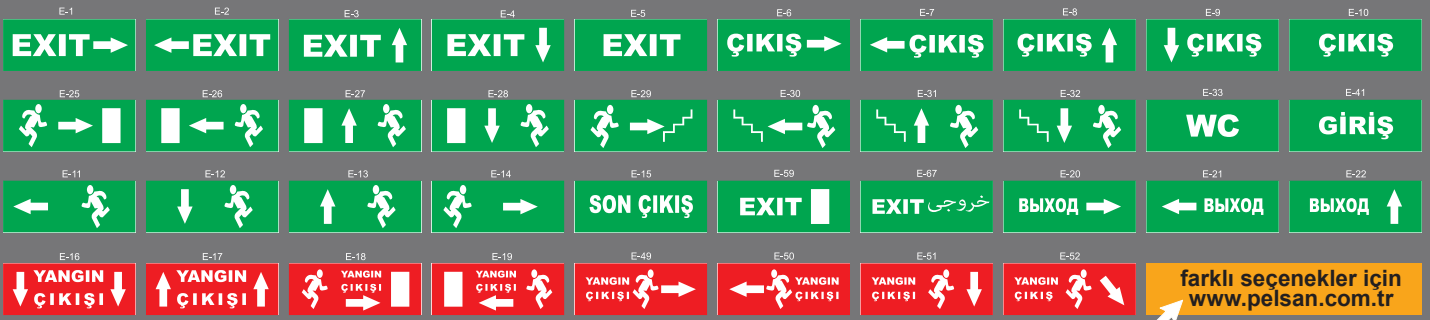

IP 20 

• Ürün Kodu ile birlikte etiket seçiminizi bildiriniz.

farklı seçenekler için  
[www.pelsan.com.tr](http://www.pelsan.com.tr)

## Linea 65

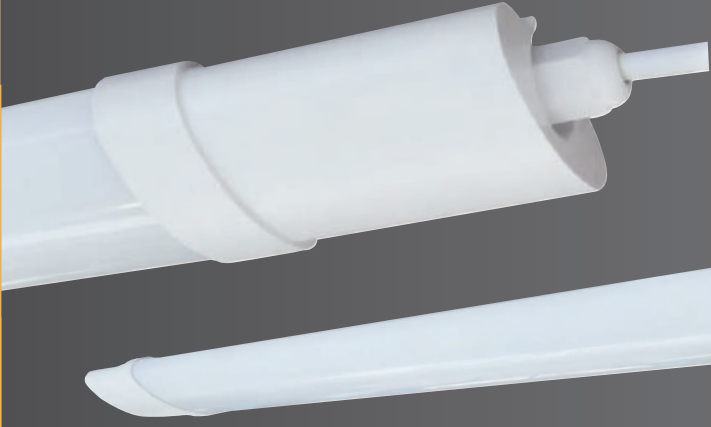

### Tozlu ve Nemli Alanlar İçin!

- Toz ve Su Almaz!
- 100 lm/W
- Kolay Kurulum

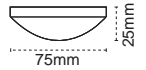

IP 65

| Kod No | Özellikler       | Koli Adedi | Fiyat    |
|--------|------------------|------------|----------|
| 108219 | 36W 6500K 1200mm | 10         | 26,70 \$ |

## Linea Large LED



### Ekonomik Bant Armatürü!

- Class II Ekstra Elektriksel Güvenlik
- Homojen Işık Çıktısı
- Kolay Kurulum

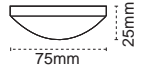

IP 40

| Kod No | Özellikler       | Koli Adedi | Fiyat    |
|--------|------------------|------------|----------|
| 107938 | 36W 4000K 1200mm | 20         | 16,50 \$ |
| 109277 | 36W 6500K 1200mm | 20         | 16,50 \$ |

## Linea LED



### Geniş Kullanım Alanı!

- Tezgah Altı
- Elektrik Panosu
- Dolap İçi



Anahtarlı



Kesintisiz Lineer Bağlantı



IP 40



| Kod No | Özellikler       | Koli Adedi | Fiyat    |
|--------|------------------|------------|----------|
| 204672 | 4W 6500K 30cm    | 30         | 6,80 \$  |
| 204671 | 16W 6500K 120 cm | 30         | 12,20 \$ |
| 306960 | Fiş Kablo        | 150        | 2,40 \$  |

**Aparatlar fiyata dahildir.**  
(Enerji kablosu, 15 cm esnek bağlantı aparatı, mini bağlantı aparatı, zemin montajı için gerekli klipsler, bitiş kapağı)

## Etanj Duyulu Sac Bant LED Tube Uygun - Impera

### Tozlu ve Titreşimli Alanlar İçin!



-  Tozlu alanlar için özel duyu yapısı!
-  Makine titreşimlerinden etkilenmez!
-  LED Tube ile %50'yi aşan tasarruf!

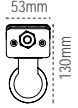

IP 54

| Kod No | Özellikler  | Koli Adedi | Fiyat    |
|--------|-------------|------------|----------|
| 108833 | Tekli 60cm  | 6          | 9,30 \$  |
| 108835 | Tekli 120cm | 6          | 10,70 \$ |
| 108837 | Tekli 150cm | 6          | 13,40 \$ |



IP 54

| Kod No | Özellikler  | Koli Adedi | Fiyat    |
|--------|-------------|------------|----------|
| 108834 | İkili 60cm  | 6          | 12,20 \$ |
| 108836 | İkili 120cm | 6          | 13,90 \$ |
| 108838 | İkili 150cm | 6          | 16,50 \$ |

## Etanj Duyulu Polyester Bant LED Tube Uygun

### Tozlu ve Nemli Alanlar İçin!



-  IP65 toz ve su almaz!
-  Anti-korozyon gövde!
-  LED Tube ile %50'yi aşan tasarruf!

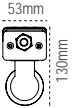

IP 65

| Kod No | Özellikler            | Koli Adedi | Fiyat    |
|--------|-----------------------|------------|----------|
| 103200 | Polyester Tekli 120cm | 12         | 20,00 \$ |
| 103261 | Polyester Tekli 150cm | 12         | 21,70 \$ |



IP 65

| Kod No | Özellikler            | Koli Adedi | Fiyat    |
|--------|-----------------------|------------|----------|
| 100374 | Polyester İkili 120cm | 6          | 22,70 \$ |
| 103268 | Polyester İkili 150cm | 6          | 24,40 \$ |

## LED Tube TMS

### Hem Tasarruflu Hem Ekonomik!



-  En ekonomik bant armatür!
-  LED Tube ile %50'yi aşan tasarruf!
-  Kolay ve hızlı kurulum!

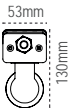

IP 20

| Kod No | Özellikler      | Koli Adedi | Fiyat   |
|--------|-----------------|------------|---------|
| 100371 | TMS Tekli 60cm  | 12         | 3,60 \$ |
| 100372 | TMS Tekli 120cm | 12         | 6,20 \$ |

IP 20

| Kod No | Özellikler      | Koli Adedi | Fiyat   |
|--------|-----------------|------------|---------|
| 109245 | TMS İkili 60cm  | 6          | 5,10 \$ |
| 100374 | TMS İkili 120cm | 6          | 8,00 \$ |

## Floresan Bant Armatürler



IP 20

| Kod No | Özellikler                       | Koli Adedi | Fiyat    |
|--------|----------------------------------|------------|----------|
| 100223 | 1x18W TMS T8 Floresan Elek. Bal. | 6          | 16,90 \$ |
| 100236 | 2x18W TMS T8 Floresan Elek. Bal. | 6          | 17,40 \$ |
| 100215 | 1x15W TMS T8 Floresan Elek. Bal. | 6          | 16,90 \$ |
| 100246 | 1x30W TMS T8 Floresan Elek. Bal. | 6          | 17,40 \$ |
| 100260 | 1x36W TMS T8 Floresan Elek. Bal. | 6          | 17,80 \$ |
| 100277 | 2x36W TMS T8 Floresan Elek. Bal. | 6          | 22,20 \$ |
| 100357 | 1x58W TMS T8 Floresan Elek. Bal. | 6          | 24,00 \$ |
| 100364 | 2x58W TMS T8 Floresan Elek. Bal. | 6          | 27,40 \$ |

IP 65

| Kod No | Özellikler                                | Koli Adedi | Fiyat    |
|--------|---|------------|----------|
| 103223 | 1x18W T8 Etanj Duyulu Sac Bant Elek. Bal. | 6          | 30,10 \$ |
| 103242 | 2x18W T8 Etanj Duyulu Sac Bant Elek. Bal. | 6          | 32,80 \$ |
| 103233 | 1x36W T8 Etanj Duyulu Sac Bant Elek. Bal. | 6          | 31,30 \$ |
| 103252 | 2x36W T8 Etanj Duyulu Sac Bant Elek. Bal. | 6          | 34,10 \$ |
| 103284 | 1x58W T8 Etanj Duyulu Sac Bant Elek. Bal. | 6          | 32,80 \$ |
| 103275 | 2x58W T8 Etanj Duyulu Sac Bant Elek. Bal. | 6          | 35,60 \$ |

**Monoline**  
Linear LED Armatür

**Yeni Ürün**



**120**  
lm/W  
verimlilik



T5 Floresana göre %60'a varan tasarruf sağlar.



ENEC belgeli sürücü



T5'e göre 2,5 kat uzun ömürlüdür.



Kolay linear bağlantı

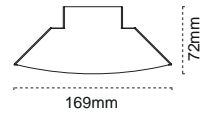

IP 40 ● 3000K ● 4000K ● 6500K

| Kod No | Özellikler                   | Koli Adedi | Fiyat    |
|--------|------------------------------|------------|----------|
| 109564 | 28W 6500K 111cm Opal Difüzör | 6          | 61,10 \$ |

| Kod No | Özellikler                   | Koli Adedi | Fiyat    |
|--------|------------------------------|------------|----------|
| 109566 | 35W 6500K 150cm Opal Difüzör | 4          | 67,30 \$ |

**Multiline**  
Linear LED Armatür



**Işığa Hareket Kazandırır!**



- 7 kademeli ayarlanabilir ışık açısı ile ışığı istediğiniz noktaya yönlendirir.
- Sürekli linear bağlantı
- Kamaşma önleyici özel difüzör
- 120 lm/W verimlilik
- ENEC belgeli sürücü

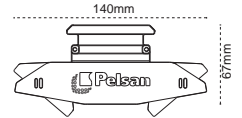

IP 40 ● 3000K ● 4000K ● 6500K

| Kod No | Özellikler                   | Koli Adedi | Fiyat     |
|--------|------------------------------|------------|-----------|
| 105381 | 35W 6500K 120cm Opal Difüzör | 4          | 117,10 \$ |
| 105383 | 35W 6500K 150cm Opal Difüzör | 4          | 141,80 \$ |
| 105385 | 50W 6500K 150cm Opal Difüzör | 4          | 151,90 \$ |

| Kod No | Özellikler                   | Koli Adedi | Fiyat     |
|--------|------------------------------|------------|-----------|
| 108508 | 35W 6500K 120cm Opal Difüzör | 4          | 121,60 \$ |
| 108509 | 35W 6500K 150cm Opal Difüzör | 4          | 144,10 \$ |
| 108416 | 50W 6500K 150cm Opal Difüzör | 4          | 156,40 \$ |

**Market Armatürü**  
T5 Floresanlı / T8 LED Tube

**En Ekonomik Çözüm!**



- T5 Floresanlı T8 LED Tube Opsiyonu
- Alüminyum Reflektör
- 120 /150 cm Boy Seçeneği

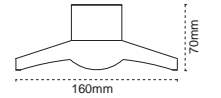

IP 20 ● 3000K ● 4000K ● 6500K

| Kod No | Özellikler           | Koli Adedi | Fiyat    |
|--------|----------------------|------------|----------|
| 105335 | 1x28W Elek. Bal. TL5 | 1          | 38,40 \$ |
| 105339 | 2x28W Elek. Bal. TL5 | 1          | 40,50 \$ |
| 105342 | 1x35W Elek. Bal. TL5 | 1          | 41,10 \$ |
| 105344 | 2x35W Elek. Bal. TL5 | 1          | 42,50 \$ |
| 105348 | 1x54W Elek. Bal. TL5 | 1          | 38,60 \$ |
| 105353 | 2x54W Elek. Bal. TL5 | 1          | 40,80 \$ |

| Kod No | Özellikler                  | Koli Adedi | Fiyat    |
|--------|-----------------------------|------------|----------|
| 105331 | T8 Market Arm. 1x18W 120 cm | 5          | 30,20 \$ |
| 105332 | T8 Market Arm. 1x24W 150 cm | 5          | 38,80 \$ |



Forza

 ENEC Belgeli Sürücü

 Kolay Montaj!

 Toz ve Su Almaz!

LED'e Özgü  
Mandalsız  
Tasarım

 IP65

 72W Florasanla Eşdeğer Işık

Forza LED, %50'yi aşan tasarruf sağlar.

 Kolay ve Hızlı Montaj

Fonksiyonel tasarıma sahip Forza, içine müdahale edilmeksizin yüzey ve kablo talarına kolay ve hızlı montaj edilir.

 Opsiyonel Lineer Bağlantı

İki tarafında bulunan klemens kapağı ile lineer bağlantıya uygundur.

Forza LED Tube



Yeni Ürün

Dahili LED TUBE

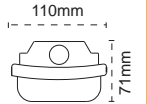

\* 1 adet LED Tube dahili kit içerir.  
\*\* 2 adet LED Tube koridor fonksiyonludur.

IP 65

| Kod No | Özellikler                       | Koli Adedi | Fiyat    |
|--------|----------------------------------|------------|----------|
| 108120 | 2x18W 4000K 120cm LED Tube Dahil | 6          | 33,10 \$ |
| 108407 | 2x18W 6500K 120cm LED Tube Dahil | 6          | 33,10 \$ |

IP 65

| Kod No | Özellikler                                      | Koli Adedi | Fiyat    |
|--------|---|------------|----------|
| 108798 | 2x18W 6500K 120cm LED Tube Dahil Acil Ayd Kit*  | 6          | 47,80 \$ |
| 109101 | 2x18W 6500K 120cm LED Tube Dahil Koridor Fonk** | 6          | 55,40 \$ |

Forza LED

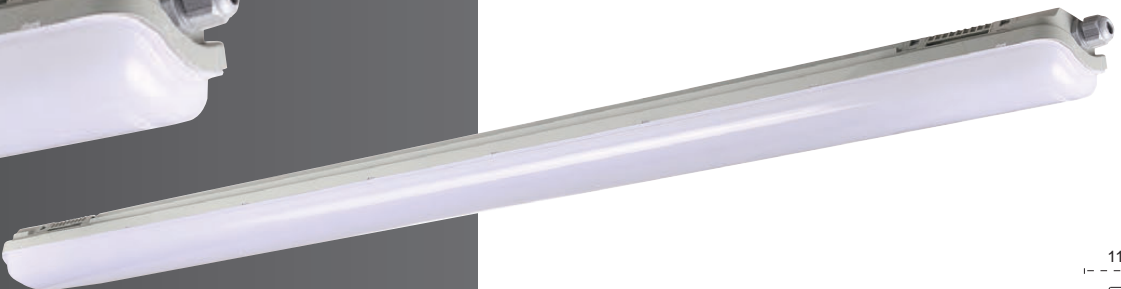
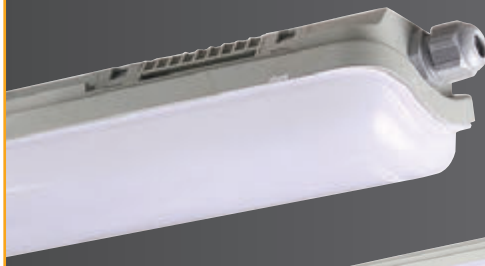

Yeni Ürün

YSE

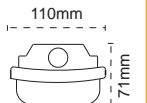

\* 1 adet LED Tube dahili kit içerir.  
\*\* 2 adet LED Tube koridor fonksiyonludur.

IP 65

| Kod No | Özellikler          | Koli Adedi | Fiyat    |
|--------|---------------------|------------|----------|
| 108887 | 36W LED 4000K 120cm | 6          | 41,60 \$ |
| 108626 | 36W LED 6500K 120cm | 6          | 41,60 \$ |

IP 65

| Kod No | Özellikler                 | Koli Adedi | Fiyat    |
|--------|----------------------------|------------|----------|
| 109706 | 36W 4000K 120cm Acil Kitli | 6          | 67,60 \$ |
| 109574 | 36W 6500K 120cm Acil Kitli | 6          | 67,60 \$ |

**Otopark Fonksiyonlu LED Etanj**  
Largo LED



**Maksimum  
Tasarruf  
Sağlar**



| Kod No | Özellikler   | Koli Adedi | Fiyat     |
|--------|--|------------|-----------|
| 109065 | 36W 6500K 120cm <b>Otopark Fonksiyonlu</b>                       | 6          | 101,30 \$ |
| 109066 | 36W 6500K 120cm <b>Otopark Fonksiyonlu Acil Aydınlatma Kitli</b> | 6          | 127,20 \$ |



**Soğuk Hava Deposu için LED Etanj**  
Largo LED Frozen



**-40°C'ye Kadar Çalışır.**

Soğuk hava depoları ve donuk ürün depoları kullanımı için uygundur.

| Kod No | Özellikler              | Koli Adedi | Fiyat     |
|--------|-------------------------|------------|-----------|
| 105871 | 21W 6500K 60cm (-25°C)  | 6          | 191,30 \$ |
| 105884 | 42W 6500K 120cm (-40°C) | 6          | 213,80 \$ |
| 105894 | 63W 6500K 150cm (-40°C) | 6          | 225,10 \$ |



**Atex Belgeli Ex-Proof Etanj**  
Largo

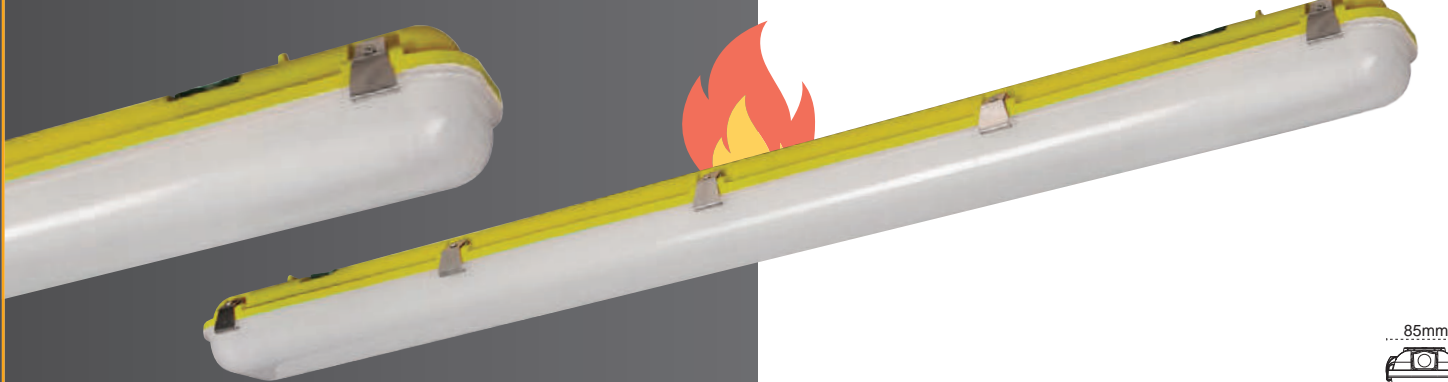

- Gaz Patlama Koruması: Zone 2**  
• II 3G Ex nR IIC T6 Gc
- Toz Patlama Koruması: Zone 22**  
• II 3D Ex tc IIC (T80 C) Dc

| Kod No | Özellikler               | Koli Adedi | Fiyat     |
|--------|--------------------------|------------|-----------|
| 108458 | 25W LED 6500K Opal 60cm  | 6          | 212,70 \$ |
| 108459 | 45W LED 6500K Opal 120cm | 6          | 230,70 \$ |
| 108297 | 2x18W T8 Şeffaf 60cm     | 6          | 115,60 \$ |
| 108298 | 2x36W T8 Şeffaf 120cm    | 6          | 131,30 \$ |



## LED Etanj Largo



IP 65

| Kod No | Özellikler      | Koli Adedi | Fiyat    |
|--------|-----------------|------------|----------|
| 109150 | 20W 6500K 60cm  | 6          | 33,30 \$ |
| 109151 | 36W 6500K 120cm | 6          | 41,60 \$ |
| 109153 | 42W 6500K 150cm | 6          | 68,60 \$ |

## LED Tube Etanj Largo

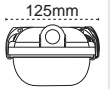
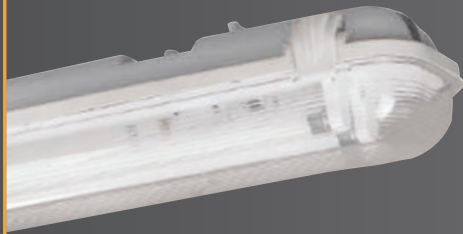

IP 65 ● 3000K ● 4000K ● 6500K

| Kod No | Özellikler                    | Koli Adedi | Fiyat    |
|--------|-------------------------------|------------|----------|
| 102669 | LED Tube Tekli 60cm           | 6          | 12,10 \$ |
| 102713 | LED Tube Tekli 120cm          | 6          | 15,30 \$ |
| 102867 | LED Tube Tekli 150cm          | 6          | 30,50 \$ |
| 102687 | LED Tube İkili 60cm           | 6          | 12,70 \$ |
| 102744 | LED Tube İkili 120cm          | 6          | 17,85 \$ |
| 102878 | LED Tube İkili 150cm          | 6          | 31,60 \$ |
| 313117 | 9-18W LED Tube Konvertör Kiti | 1          | 26,00 \$ |

● Acil aydınlatma kiti uygulanabilir (9-18W)

## LED Tube Etanj Mar

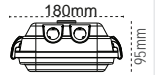

IP 65 ● 4000K ● 6500K

| Kod No | Özellikler            | Koli Adedi | Fiyat    |
|--------|-----------------------|------------|----------|
| 108801 | LED Tube Üçlü 60cm    | 4          | 23,30 \$ |
| 108800 | LED Tube Üçlü 120cm   | 4          | 27,35 \$ |
| 102577 | LED Tube Üçlü 150cm   | 4          | 36,90 \$ |
| 108802 | LED Tube Dörtlü 60cm  | 4          | 38,80 \$ |
| 102574 | LED Tube Dörtlü 120cm | 4          | 48,50 \$ |
| 102579 | LED Tube Dörtlü 150cm | 4          | 52,40 \$ |

## T8 Floresan Etanj Largo

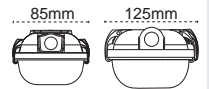
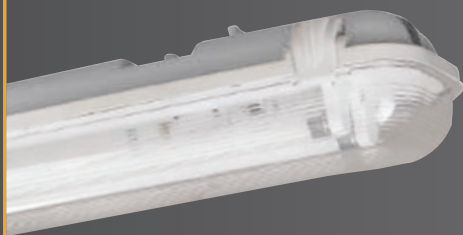

IP 65

| Kod No | Özellikler           | Koli Adedi | Fiyat    |
|--------|----------------------|------------|----------|
| 102677 | 1x18W Elek. Bal. TLD | 6          | 21,10 \$ |
| 102724 | 1x36W Elek. Bal. TLD | 6          | 28,40 \$ |
| 102872 | 1x58W Elek. Bal. TLD | 6          | 45,20 \$ |
| 102697 | 2x18W Elek. Bal. TLD | 6          | 23,20 \$ |
| 102761 | 2x36W Elek. Bal. TLD | 6          | 33,70 \$ |
| 102883 | 2x58W Elek. Bal. TLD | 6          | 54,70 \$ |

**Solida**



**Alüminyum  
Gövde**

RS

**5** yıl  
garanti

IP65

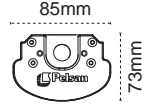

IP 65 3000K 4000K 6500K

| Kod No | Özellikler      | Koli Adedi | Fiyat     |
|--------|-----------------|------------|-----------|
| 105599 | 23W 6500K 60cm  | 6          | 70,70 \$  |
| 105603 | 35W 6500K 90cm  | 6          | 97,70 \$  |
| 105606 | 45W 6500K 120cm | 6          | 123,80 \$ |
| 105609 | 65W 6500K 120cm | 6          | 135,10 \$ |

**Prota**



**Alüminyum  
Gövde**

RS

IP65

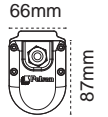

IP 65 3000K 4000K 6500K

| Kod No | Özellikler      | Koli Adedi | Fiyat    |
|--------|-----------------|------------|----------|
| 109145 | 20W 6500K 60cm  | 6          | 51,90 \$ |
| 109147 | 27W 6500K 90cm  | 6          | 77,10 \$ |
| 109148 | 35W 6500K 120cm | 6          | 92,40 \$ |

**Inovaled IP66**



**Alüminyum  
Gövde**

**5** yıl  
garanti

IP66

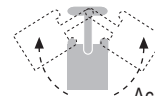

IP 66 3000K 4000K 6500K

| Kod No | Özellikler                     | Koli Adedi | Fiyat     |
|--------|--------------------------------|------------|-----------|
| 105597 | 21W 6500K 60 cm                | 6          | 67,60 \$  |
| 105593 | 42W 6500K 120 cm               | 6          | 104,00 \$ |
| 105585 | 45W 6500K 150 cm               | 6          | 124,80 \$ |
| 311186 | Açı Ayarlı Montaj Aparatı 2'li | 6          | 5,70 \$   |



Darıca Opet aydınlatma projesinde Pelsan marka kanopi armatürleri kullanılmıştır.

## Okta Waterproof IP65 LED Kanopi Armatür



**Şok Fiyat**  
**153,10\$**

- ENEC Belgeli Sürücü
- +50.000 Saat Ömür
- IP65, Toz ve Su Almaz!

Alüminyum  
Gövde

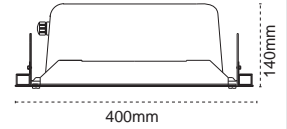

IP 65 4000K 6500K

| Kod No | Özellikler         | Koli Adedi | Fiyat     |
|--------|--------------------|------------|-----------|
| 106627 | Okta LED 80W 6500K | 1          | 153,10 \$ |

## Piroliz Ex-Proof IP66 LED Kanopi Armatür

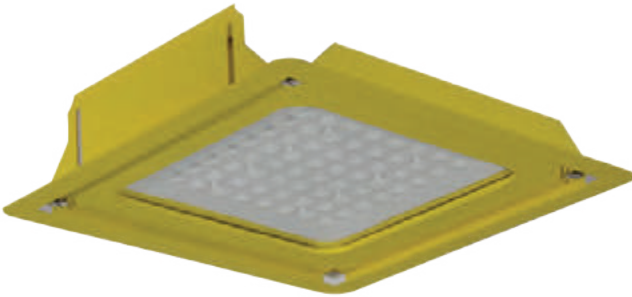

- Gaz Patlama Koruması:** II 3G Ex nR IIC T5 Gc
- Toz Patlama Koruması:** II 3D Ex tc IIIC (T95 C) Dc

Alüminyum  
Enjeksiyon

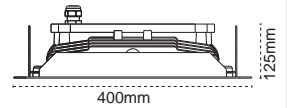

IP 66 4000K 6500K

| Kod No | Özellikler            | Koli Adedi | Fiyat     |
|--------|-----------------------|------------|-----------|
| 106578 | Piroliz Ex 50W 6500K  | 1          | 514,60 \$ |
| 106579 | Piroliz Ex 75W 6500K  | 1          | 581,30 \$ |
| 106580 | Piroliz Ex 100W 6500K | 1          | 648,10 \$ |
| 106581 | Piroliz Ex 125W 6500K | 1          | 715,60 \$ |
| 106582 | Piroliz Ex 150W 6500K | 1          | 782,30 \$ |

## Piroliz Waterproof IP65 LED Kanopi Armatür



- ENEC Belgeli Sürücü
- +50.000 Saat Ömür
- IP65, Alüminyum Enjeksiyon Gövde

Alüminyum  
Enjeksiyon

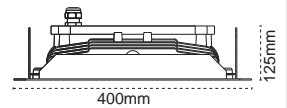

IP 65 4000K 6500K

| Kod No | Özellikler | Koli Adedi | Fiyat     |
|--------|------------|------------|-----------|
| 106583 | 75W 6500K  | 1          | 309,40 \$ |
| 106584 | 100W 6500K | 1          | 309,40 \$ |
| 106585 | 125W 6500K | 1          | 309,40 \$ |

**Etna LED**  
IP65 Yüksek Tavan Armatürü



**Ultra Performans!**

**7/24 Çalışan**  
**Endüstriyel Tesislerde**  
**Ultra Performans!**

**5** Yıl  
Garanti

**Yeni Ürün**



**ENEC Belgeli Sürücü**  
**Ömür +100.000 Saat**



**+72.000 Saat**  
**LED Çip Ömrü**



**150 lm/W'a Varan**  
**Etkinlik Faktörü**



**5** Yıl  
Garanti



Montaj Uygulaması

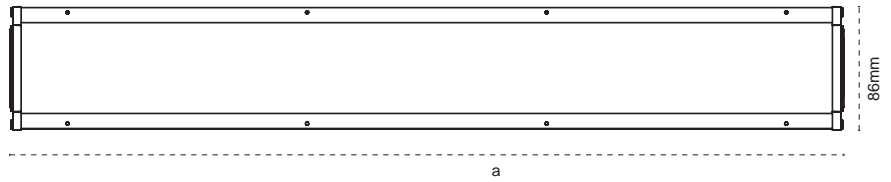
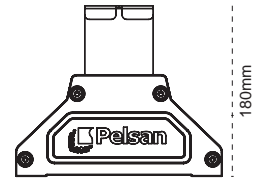

IP 65 ⊕ 4000K 6500K

| Kod No | Özellikler | Dar Açı | a (mm) | Koli Adedi | Fiyat     |
|--------|------------|---------|--------|------------|-----------|
| 108526 | 80W 6500K  | Dar Açı | 120cm  | 1          | 245,10 \$ |
| 108524 | 100W 6500K | Dar Açı | 120cm  | 1          | 255,10 \$ |
| 108532 | 125W 6500K | Dar Açı | 150cm  | 1          | 300,10 \$ |
| 108534 | 140W 6500K | Dar Açı | 150cm  | 1          | 310,10 \$ |
| 108688 | 200W 6500K | Dar Açı | 150cm  | 1          | 375,10 \$ |

IP 65 ⊕ 4000K 6500K

| Kod No | Özellikler | Geniş Açı | a (mm) | Koli Adedi | Fiyat     |
|--------|------------|-----------|--------|------------|-----------|
| 108527 | 80W 6500K  | Geniş Açı | 120cm  | 1          | 245,10 \$ |
| 108525 | 100W 6500K | Geniş Açı | 120cm  | 1          | 255,10 \$ |
| 108533 | 125W 6500K | Geniş Açı | 150cm  | 1          | 300,10 \$ |
| 108535 | 140W 6500K | Geniş Açı | 150cm  | 1          | 310,10 \$ |
| 108690 | 200W 6500K | Geniş Açı | 150cm  | 1          | 375,10 \$ |

**Hima LED**  
IP65 Yüksek Tavan Armatürü



 **Ekonomik Fiyat!**



**+50.000 Saat Armatür Ömrü**



**ENEC Belgeli Sürücü**



**Su Almaz! IP65**



Sensör Uygulaması



Detay



Busbar Aparatı

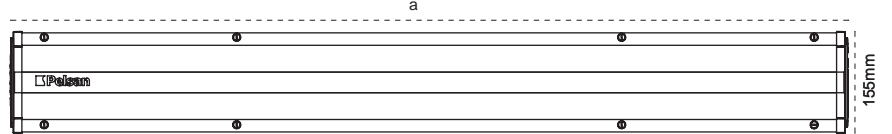
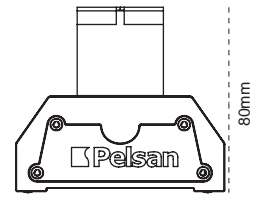

IP 65   4000K  6500K

| Kod No | Özellikler               | a (mm) | Koli Adedi | Fiyat     | Kod No | Özellikler | a (mm) | Koli Adedi | Fiyat     |
|--------|--------------------------|--------|------------|-----------|--------|------------|--------|------------|-----------|
| 108225 | 75W 6500K                | 120cm  | 1          | 136,20 \$ | 108672 | 100W 6500K | 120cm  | 1          | 165,10 \$ |
| 108372 | 75W 6500K Sensörlü       | 120cm  | 1          | 154,20 \$ | 108674 | 125W 6500K | 150cm  | 1          | 210,10 \$ |
| 108373 | 75W 6500K Sensörlü Kitli | 120cm  | 1          | 245,30 \$ |        |            |        |            |           |

**Sia**  
IP65 Alm. Enj. Yüksek Tavan Armatürü

**Yeni Ürün**



**140**  
lm/W  
verimlilik



ENEC Belgili Sürücü



Faklı İhtiyaçlara Uygun Optik Çözüm



IP65 Toz ve Su Almaz

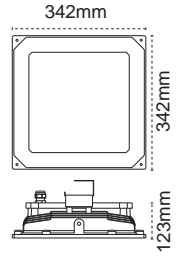

IP 65 4000K 6500K

| Kod No | Özellikler | Koli Adedi | Fiyat     |
|--------|------------|------------|-----------|
| 109221 | 150W 6500K | 1          | 343,20 \$ |

IP 65 4000K 6500K

| Kod No | Özellikler | Koli Adedi | Fiyat     |
|--------|------------|------------|-----------|
| 109554 | 200W 6500K | 1          | 362,30 \$ |

**Castor**  
IP65 Alm. Enj. Yüksek Tavan Armatürü

**Yeni Ürün**

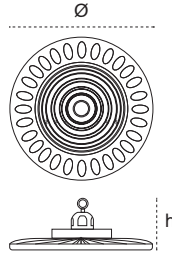

IP 65

| Kod No | Özellikler | Koli Adedi | Fiyat     |
|--------|------------|------------|-----------|
| 107995 | 100W 5700K | 6          | 138,10 \$ |
| 108122 | 150W 5700K | 4          | 216,10 \$ |
| 107996 | 200W 5700K | 3          | 296,20 \$ |

**Monte**  
IP65 Alm. Enj. Yüksek Tavan Armatürü

**Yeni Ürün**

CE



IP 65

| Kod No | Özellikler | Koli Adedi | Fiyat     |
|--------|------------|------------|-----------|
| 109451 | 100W 5700K | 6          | 85,60 \$  |
| 109452 | 150W 5700K | 1          | 127,60 \$ |

**Gediz**  
Atölye  
Armatürü

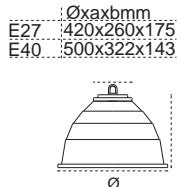

IP 65/20

| Kod No | Özellikler                | Koli Adedi | Fiyat    |
|--------|---------------------------|------------|----------|
| 104128 | Gediz Alm. Atölye Arm E27 | 10         | 21,10 \$ |
| 104136 | Gediz Alm. Atölye Arm E40 | 10         | 27,40 \$ |
| 311067 | Q402mm Cam+Conta+Klips    | 10         | 11,60 \$ |
| 311144 | Q420mm Tel Kafes          | 1          | 8,50 \$  |

**Fırat**  
Atölye  
Armatürü

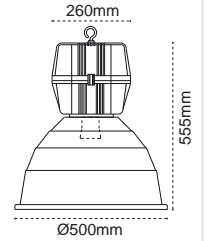

IP 65/20

| Kod No | Özellikler                              | Koli Adedi | Fiyat    |
|--------|---|------------|----------|
| 104142 | Fırat 250W E40 MH/SB Poly. Atölye Arm.  | 4          | 82,00 \$ |
| 104149 | Fırat 400W E40 MH Poly. Atölye Arm.     | 4          | 85,10 \$ |
| 104153 | Fırat 400W E40 SB Poly. Atölye Arm.     | 4          | 94,60 \$ |
| 311068 | Atölye Camı (482X4mm) + Conta ve Mandal | 1          | 13,80 \$ |
| 311145 | 400W Atölye Tel Kafes                   | 1          | 11,10 \$ |

**Tuna**

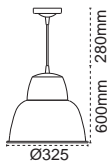

IP 65

| Kod No | Özellikler   | Koli Adedi | Fiyat    |
|--------|--------------|------------|----------|
| 104278 | Tuna E27 Q33 | 4          | 22,10 \$ |

**Sana**

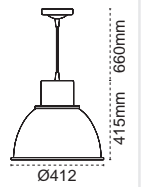

IP 65

| Kod No | Özellikler   | Koli Adedi | Fiyat    |
|--------|--------------|------------|----------|
| 104282 | Sana E27 Q44 | 4          | 31,60 \$ |





## Süphan T5 IP65 Yüksek Tavan Armatürü

**SOK FİYAT**  
**73,80\$**



GRP Gövde



Temperli Cam



2x54W / 2x80W

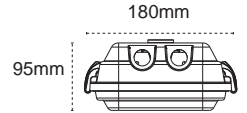

IP 65

IP 65

| Kod No | Özellikler      | Koli Adedi | Fiyat    | Kod No | Özellikler      | Koli Adedi | Fiyat    |
|--------|-----------------|------------|----------|--------|-----------------|------------|----------|
| 109222 | 2x54W T5 120 cm | 1          | 73,80 \$ | 109223 | 2x80W T5 150 cm | 1          | 83,50 \$ |

## Karpat T5 IP65 Yüksek Tavan Armatürü

Busbar Askı Uygulaması



axbxcmm  
2x54W:1210x190x82  
4x54W:1210x345x82  
2x80W:1510x190x82  
4x80W:1510x345x82

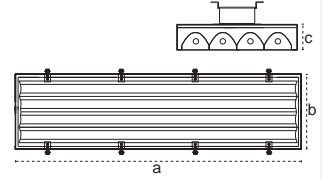

IP 65

IP 65

| Kod No | Özellikler      | Koli Adedi | Fiyat     | Kod No | Özellikler      | Koli Adedi | Fiyat     |
|--------|-----------------|------------|-----------|--------|-----------------|------------|-----------|
| 100778 | 2X54W T5 120 cm | 1          | 77,60 \$  | 101262 | 2X80W T5 150 cm | 1          | 89,30 \$  |
| 100790 | 4X54W T5 120 cm | 1          | 135,80 \$ | 101282 | 4X80W T5 150 cm | 1          | 174,60 \$ |

## Oriza T5 IP65 Yüksek Tavan Armatürü

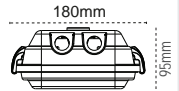

IP 65

IP 65

| Kod No | Özellikler      | Koli Adedi | Fiyat    | Kod No | Özellikler      | Koli Adedi | Fiyat    |
|--------|-----------------|------------|----------|--------|-----------------|------------|----------|
| 103457 | 2X54W T5 120 cm | 1          | 64,10 \$ | 103460 | 2X80W T5 150 cm | 1          | 79,50 \$ |

## Mar LED Tube IP65 Yüksek Tavan Armatürü

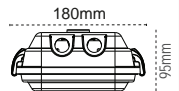

IP 65

IP 65

| Kod No | Özellikler             | Koli Adedi | Fiyat    | Kod No | Özellikler             | Koli Adedi | Fiyat    |
|--------|------------------------|------------|----------|--------|------------------------|------------|----------|
| 108801 | LED Tube Üçlü 60 cm    | 4          | 23,30 \$ | 102577 | LED Tube Üçlü 150 cm   | 4          | 48,50 \$ |
| 108802 | LED Tube Dörtlü 60 cm  | 4          | 25,30 \$ | 102579 | LED Tube Dörtlü 150 cm | 4          | 52,40 \$ |
| 108800 | LED Tube Üçlü 120 cm   | 4          | 36,90 \$ |        |                        |            |          |
| 102574 | LED Tube Dörtlü 120 cm | 4          | 38,80 \$ |        |                        |            |          |



# ATEX Belgeli Ex-Proof Armatürler

- Toz Patlama Koruması: Zone 22
- Gaz Patlama Koruması: Zone 2

**LED Ex-Proof**  
Largo IP65 Etanj 60cm

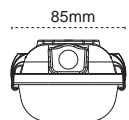
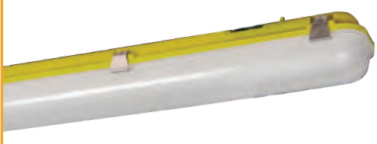

IP 65 4000K 6500K

| Kod No | Özellikler                   | Koli Adedi | Fiyat     |
|--------|------------------------------|------------|-----------|
| 108458 | Largo Ex 25W 60cm Opal 6500K | 6          | 212,70 \$ |

**T8 Ex-Proof**  
Largo IP65 Etanj 60cm



IP 65

| Kod No | Özellikler            | Koli Adedi | Fiyat     |
|--------|-----------------------|------------|-----------|
| 108297 | Largo Ex 2x18W Şeffaf | 6          | 115,60 \$ |

**LED Ex-Proof**  
Largo IP65 Etanj 120cm



IP 65 4000K 6500K

| Kod No | Özellikler                    | Koli Adedi | Fiyat     |
|--------|-------------------------------|------------|-----------|
| 108459 | Largo Ex 45W 120cm Opal 6500K | 6          | 230,70 \$ |

**T8 Ex-Proof**  
Largo IP65 Etanj 120cm





IP 65

| Kod No | Özellikler            | Koli Adedi | Fiyat     |
|--------|-----------------------|------------|-----------|
| 108298 | Largo Ex 2x36W Şeffaf | 6          | 131,30 \$ |

**Ex-Proof Acil Aydınlatma  
Yönlendirme Armatürü  
Ausled (3 Saat)**

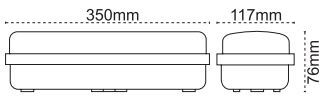
**Yeni Ürün**



IP 65 4000K 6500K

| Kod No | Özellikler         | Koli Adedi | Fiyat    |
|--------|--------------------|------------|----------|
| 109710 | Ausled Ex 8W 6500K | 12         | 52,90 \$ |

**Ex-Proof E-Tipi Armatür  
Oval Kafes**

**Yeni Ürün**

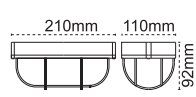
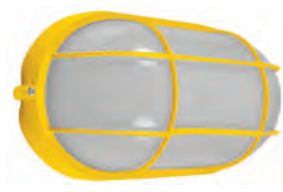

IP 65

| Kod No | Özellikler   | Koli Adedi | Fiyat    |
|--------|--------------|------------|----------|
| 109713 | 1xE27 Duyulu | 18         | 44,50 \$ |



# ATEX Belgeli Ex-Proof Armatürler

Toz Patlama Koruması: Zone 22  
Gaz Patlama Koruması: Zone 2

## Ex-Proof Yüksek Tavan Arm. Sia

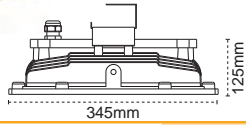
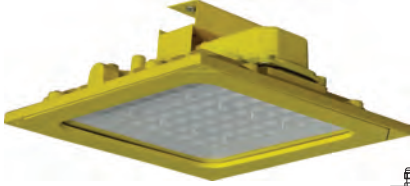

IP 66 4000K 6500K

| Kod No | Özellikler        | Koli Adedi | Fiyat     |
|--------|-------------------|------------|-----------|
| 106615 | Sia Ex 50W 6500K  | 1          | 514,60 \$ |
| 106616 | Sia Ex 75W 6500K  | 1          | 581,30 \$ |
| 106617 | Sia Ex 100W 6500K | 1          | 648,10 \$ |
| 106618 | Sia Ex 125W 6500K | 1          | 715,60 \$ |
| 106619 | Sia Ex 150W 6500K | 1          | 782,30 \$ |

## Ex-Proof Kanopi Armatürü Piroliz

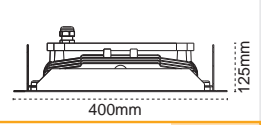
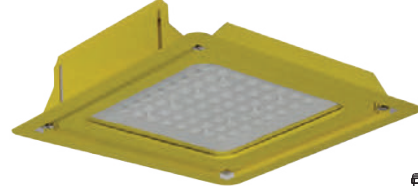

IP 66 4000K 6500K

| Kod No | Özellikler            | Koli Adedi | Fiyat     |
|--------|-----------------------|------------|-----------|
| 106578 | Piroliz Ex 50W 6500K  | 1          | 514,60 \$ |
| 106579 | Piroliz Ex 75W 6500K  | 1          | 581,30 \$ |
| 106580 | Piroliz Ex 100W 6500K | 1          | 648,10 \$ |
| 106581 | Piroliz Ex 125W 6500K | 1          | 715,60 \$ |
| 106582 | Piroliz Ex 150W 6500K | 1          | 782,30 \$ |

## Ex-Proof Projektör Nairo

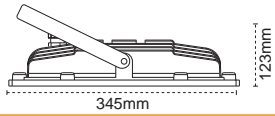

IP 66 4000K 6500K

| Kod No | Özellikler          | Koli Adedi | Fiyat     |
|--------|---------------------|------------|-----------|
| 106498 | Nairo Ex 50W 6500K  | 1          | 514,60 \$ |
| 106499 | Nairo Ex 75W 6500K  | 1          | 581,30 \$ |
| 106500 | Nairo Ex 100W 6500K | 1          | 648,10 \$ |
| 106501 | Nairo Ex 125W 6500K | 1          | 715,60 \$ |
| 106502 | Nairo Ex 150W 6500K | 1          | 782,30 \$ |

## Ex-Proof Projektör Lirad

Yeni Ürün

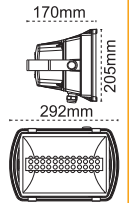

IP 65 4000K 6500K

| Kod No | Özellikler         | Koli Adedi | Fiyat     |
|--------|--------------------|------------|-----------|
| 109707 | Lirad Ex 50W 6500K | 1          | 122,50 \$ |

## Ex-Proof Yol-Cadde Armatürü Nairo

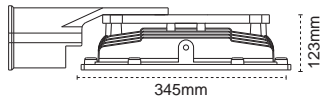

IP 66 4000K 6500K

| Kod No | Özellikler          | Koli Adedi | Fiyat     |
|--------|---------------------|------------|-----------|
| 108991 | Nairo Ex 100W 4000K | 1          | 729,10 \$ |
| 108990 | Nairo Ex 125W 4000K | 1          | 805,00 \$ |
| 108989 | Nairo Ex 150W 4000K | 1          | 880,10 \$ |

## Ex-Proof Acil Aydınlatma Yönlendirme Armatürü Ausled (3 Saat)

Yeni Ürün

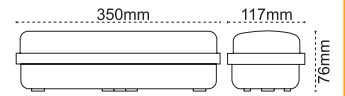

IP 65 4000K 6500K

| Kod No | Özellikler         | Koli Adedi | Fiyat    |
|--------|--------------------|------------|----------|
| 109710 | Ausled Ex 8W 6500K | 1          | 52,90 \$ |

# Pelsan Yüksek Güçlü LED Projektörler

## 500W LED Projektör

Rinto



**500W LED**  
1000W MH Eşdeğer

Arka Yüz Görünüm

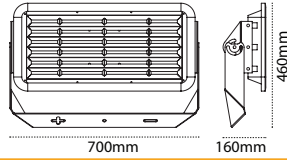

IP 65 4000K 6500K

| Kod No | Özellikler | Koli Adedi | Fiyat     |
|--------|------------|------------|-----------|
| 109718 | 430W 5700K | 1          | 900,10 \$ |
| 109719 | 500W 5700K | 1          | 950,10 \$ |

Geniş Alanlar için

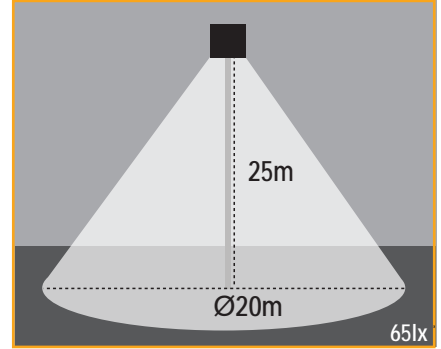

## 300-500W LED Projektör

Maxled

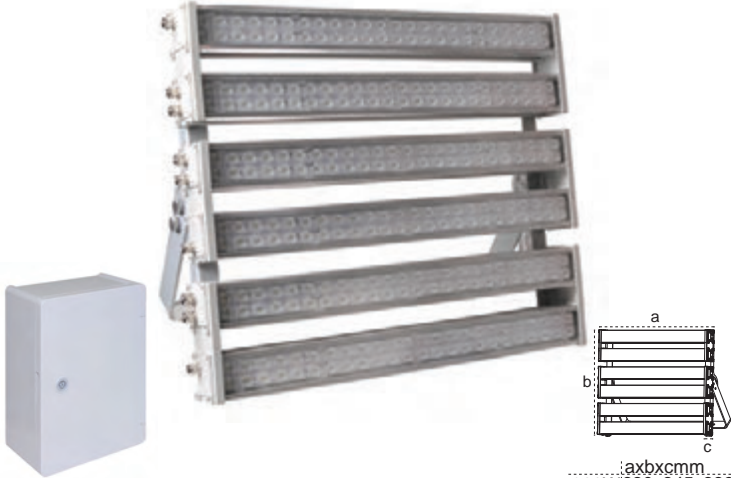

Harici Güç Panosu

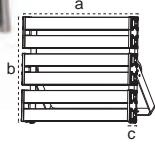

axbxcmm  
300W 630x345x339  
500W 630x515x339

IP 66 4000K 6500K

| Kod No | Özellikler | Koli Adedi | Fiyat       |
|--------|------------|------------|-------------|
| 107142 | 300W 6500K | 1          | 675,10 \$   |
| 107143 | 500W 6500K | 1          | 1.125,10 \$ |

Harici Güç Panosu ile  
Kolay Müdahale!

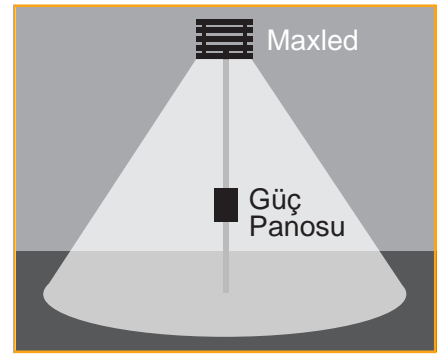

## 430W LED Projektör

Ria



**430W LED**

Arka Yüz Görünüm

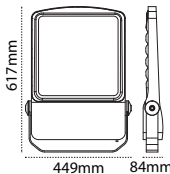

IP 66 4000K 6500K

| Kod No | Özellikler                  | Koli Adedi | Fiyat       |
|--------|-----------------------------|------------|-------------|
| 109720 | 430W 5700K (Lens Açısı 90°) | 1          | 1.050,10 \$ |

Farklı Lens Açı Opsiyonları

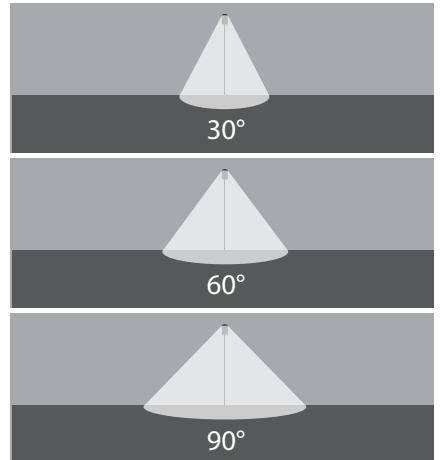

**Ria IP66**  
430W

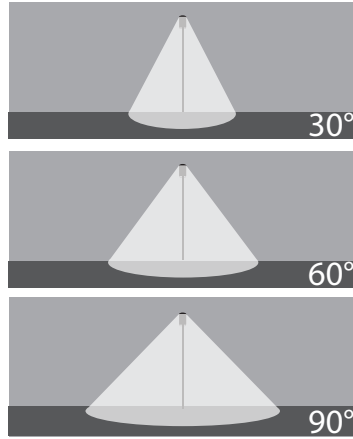

**30°-60°-90°**  
Farklı Lens Açılı...  
Farklı Lens Açılı...

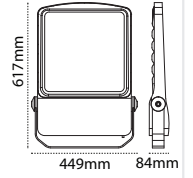

IP 66 4000K 6500K

| Kod No | Özellikler                  | Koli Adedi | Fiyat       |
|--------|-----------------------------|------------|-------------|
| 109720 | 430W 5700K (Lens Açısı 90°) | 1          | 1.050,10 \$ |

**Ria IP66 Simetrik**  
180-300W

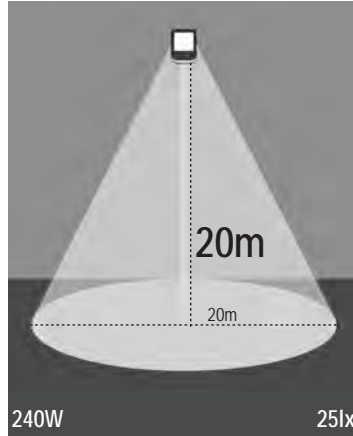

**EN YÜKSEK**  
Direkler İçin...

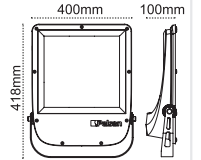

IP 66 4000K 6500K

| Kod No | Özellikler          | Koli Adedi | Fiyat     |
|--------|---------------------|------------|-----------|
| 107140 | 180W Simetrik 6500K | 1          | 360,10 \$ |
| 107141 | 200W Simetrik 6500K | 1          | 382,60 \$ |
| 107130 | 240W Simetrik 6500K | 1          | 416,30 \$ |
| 109218 | 300W Simetrik 6500K | 1          | 450,10 \$ |

**Ria IP66 Asimetrik**  
180-240W



**İŞIĞI UZAĞA ATAN**  
Asimetrik Tasarım

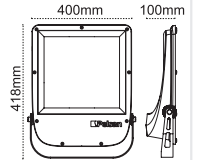

IP 66 4000K 6500K

| Kod No | Özellikler           | Koli Adedi | Fiyat     |
|--------|----------------------|------------|-----------|
| 107137 | 180W Asimetrik 6500K | 1          | 360,10 \$ |
| 107138 | 200W Asimetrik 6500K | 1          | 382,60 \$ |
| 107127 | 240W Asimetrik 6500K | 1          | 416,30 \$ |

**Ria IP66**  
100-150W

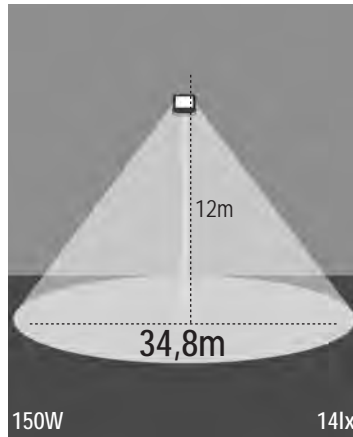

**GENİŞ**  
Alanlar için...

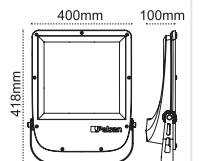

IP 66 4000K 6500K

| Kod No | Özellikler          | Koli Adedi | Fiyat     |
|--------|---------------------|------------|-----------|
| 109209 | 100W Simetrik 6500K | 1          | 248,60 \$ |
| 109210 | 125W Simetrik 6500K | 1          | 260,60 \$ |
| 109211 | 150W Simetrik 6500K | 1          | 272,60 \$ |

Ria MED

100W'ın iyisi  
**Ria  
MED**  
☆☆☆

**W** 100W

13.300 lm

IP66 Toz ve Su Almaz!



Uygulama Önerisi

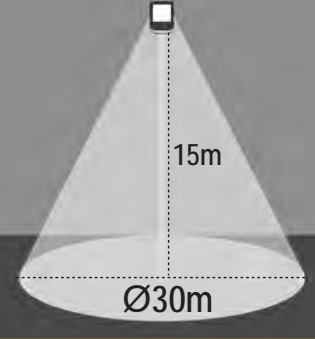

13,75lx

TSE

+54.000 Saat Ömür

ENEC Belgeli  
Sürücü

Su Almaz!  
(IP66)

Kırılmaz!  
(IK09)

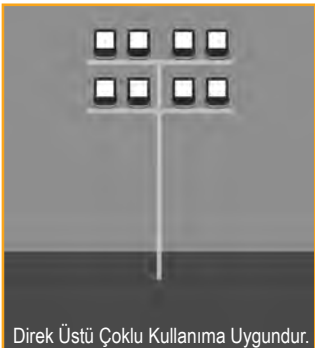

Direk Üstü Çoklu Kullanıma Uygundur.

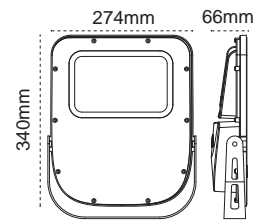

IP 66 4000K 6500K

| Kod No | Özellikler | Koli Adedi | Fiyat     |
|--------|------------|------------|-----------|
| 108560 | 50W 6500K  | 4          | 170,20 \$ |
| 108562 | 80W 6500K  | 4          | 174,90 \$ |
| 108564 | 100W 6500K | 4          | 174,90 \$ |

## Sterio



**W** 50-100-200-300-450-600W  
Güç Opsiyonu

 Özgün Tasarım,  
Modüler Dizayn

 IP66 Su ve Toz Almaz!



**Yeni\* Ürün**

### Sterio IP66 450-600W LED Projektör

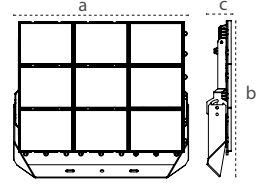

IP 66

| Kod No | Özellikler | axbxc      | Koli Adedi | Fiyat     |
|--------|------------|------------|------------|-----------|
| 109538 | 450W 5700K | 795x390x85 | 1          | 544,50 \$ |
| 109665 | 600W 5700K | 795x540x85 | 1          | 726,70 \$ |

### Sterio IP66 300W LED Projektör

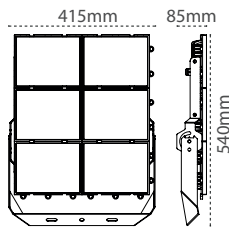

IP 66

| Kod No | Özellikler | Koli Adedi | Fiyat     |
|--------|------------|------------|-----------|
| 109537 | 300W 5700K | 1          | 355,60 \$ |

### Sterio IP66 200W LED Projektör

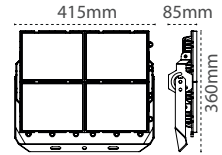

IP 66

| Kod No | Özellikler | Koli Adedi | Fiyat     |
|--------|------------|------------|-----------|
| 109536 | 200W 5700K | 1          | 218,90 \$ |

### Sterio IP66 100W LED Projektör

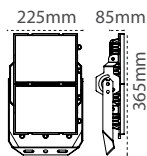

IP 66

| Kod No | Özellikler | Koli Adedi | Fiyat    |
|--------|------------|------------|----------|
| 109666 | 100W 5700K | 1          | 95,80 \$ |

### Sterio IP66 50W LED Projektör

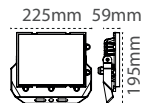

IP 66

| Kod No | Özellikler | Koli Adedi | Fiyat    |
|--------|------------|------------|----------|
| 109787 | 50W 5700K  | 1          | 47,90 \$ |

# Pelsan LED Projektörler

## Franko 400W

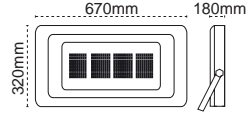

IP 65

| Kod No | Özellikler | Koli Adedi | Fiyat     |
|--------|------------|------------|-----------|
| 107117 | 400W 5000K | 1          | 468,10 \$ |

## Franko 250W

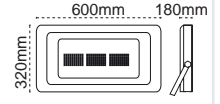

IP 65

| Kod No | Özellikler | Koli Adedi | Fiyat     |
|--------|------------|------------|-----------|
| 107115 | 250W 5000K | 1          | 283,40 \$ |

## Franko 200W

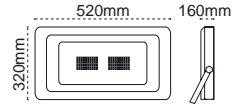

IP 65

| Kod No | Özellikler | Koli Adedi | Fiyat     |
|--------|------------|------------|-----------|
| 107112 | 200W 5000K | 1          | 199,70 \$ |

## Franko 150W

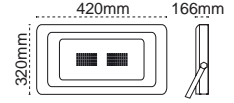

IP 65

| Kod No | Özellikler | Koli Adedi | Fiyat     |
|--------|------------|------------|-----------|
| 107109 | 150W 5000K | 2          | 148,10 \$ |

## Franko 100W

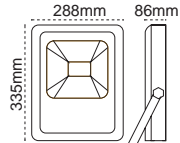

IP 65

| Kod No | Özellikler | Koli Adedi | Fiyat    |
|--------|------------|------------|----------|
| 107105 | 100W 4000K | 4          | 81,40 \$ |
| 107106 | 100W 6500K | 4          | 81,40 \$ |

## Franko 50W

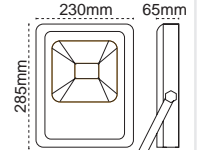

IP 65

| Kod No | Özellikler | Koli Adedi | Fiyat    |
|--------|------------|------------|----------|
| 107101 | 50W 4000K  | 6          | 44,40 \$ |
| 107102 | 50W 6500K  | 6          | 44,40 \$ |

## Franko 50W Amber - Yeşil



Amber

Yeşil

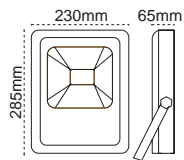

IP 65

| Kod No | Özellikler | Koli Adedi | Fiyat    |
|--------|------------|------------|----------|
| 108166 | 50W Amber  | 6          | 55,60 \$ |
| 108167 | 50W Yeşil  | 6          | 55,60 \$ |

## Franko 30W

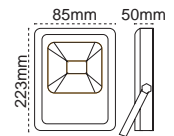

IP 65

| Kod No | Özellikler | Koli Adedi | Fiyat    |
|--------|------------|------------|----------|
| 107100 | 30W 6500K  | 10         | 30,30 \$ |



## 150W LED Projektör Lecto

**%30 Daha Fazla Işık!**

Lecto, piyasadaki sıradan slim projektörlerden %30 daha fazla ışık verir.



**100**  
lm/W  
verimlilik



Metal Rakor ile Su Almaz!



Hava Ventili ile Nem Yapmaz!



360 Döner Konsol!

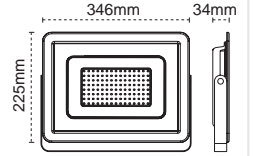

IP 65

| Kod No | Özellikler |
|--------|------------|
| 109306 | 150W 5000K |

| Koli Adedi | Fiyat    |
|------------|----------|
| 2          | 84,40 \$ |

## 100W LED Projektör Lecto

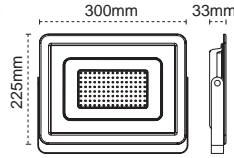

IP 65

| Kod No | Özellikler | Koli Adedi | Fiyat    |
|--------|------------|------------|----------|
| 109305 | 100W 5000K | 4          | 55,60 \$ |

## 50W LED Projektör Lecto

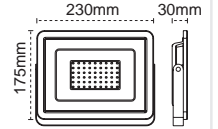

IP 65

| Kod No | Özellikler |
|--------|------------|
| 109304 | 50W 5000K  |

| Koli Adedi | Fiyat    |
|------------|----------|
| 6          | 31,10 \$ |

## Acil Kitli LED Projektör 100W

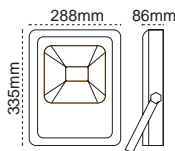

**1**  
saat

Acil Durum  
Aydınlatma

IP 65

| Kod No | Özellikler | Koli Adedi | Fiyat     |
|--------|------------|------------|-----------|
| 109732 | 100W 6500K | 4          | 109,10 \$ |

## Radar Sensörlü LED Projektör 50W

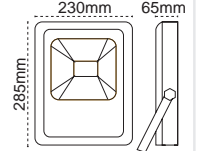

IP 65

| Kod No | Özellikler               |
|--------|--------------------------|
| 108932 | 50W 6500K Radar Sensörlü |

| Koli Adedi | Fiyat    |
|------------|----------|
| 6          | 60,70 \$ |

## Erbaled 20W



Alüminyum  
Enjeksiyon

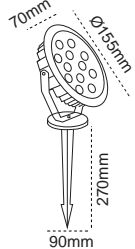

6500K

4500K

Amber

Yeşil

IP 65

| Kod No | Özellikler           | Koli Adedi | Fiyat    |
|--------|----------------------|------------|----------|
| 108005 | 20W 6500K            | 10         | 41,60 \$ |
| 204261 | Saplama Aparatı 21cm | 1          | 4,60 \$  |

## Dar Açılı LED Projektör Leveled

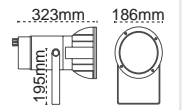

IP 65

| Kod No | Özellikler        | Koli Adedi | Fiyat    |
|--------|-------------------|------------|----------|
| 104300 | 70W Metal CDM-T   | 4          | 43,60 \$ |
| 104301 | 150W Metal CDM-T  | 4          | 46,15 \$ |
| 107758 | Leveled 25W 6500K | 4          | 87,80 \$ |

**Olimpiad 1000W-400w**  
Simetrik  
Fiberglass



**1000W**

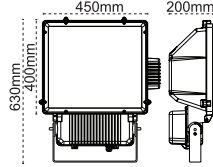

IP 65

| Kod No | Özellikler         | Koli Adedi | Fiyat     |
|--------|--------------------|------------|-----------|
| 105256 | 400W Metal MH      | 1          | 105,10 \$ |
| 105137 | 1000W Metal, MH/SB | 1          | 198,50 \$ |

**Yeno 250-400W Simetrik**  
Fiberglass



**400W**

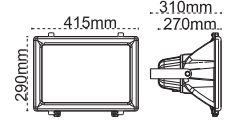

IP 65

| Kod No | Özellikler       | Koli Adedi | Fiyat    |
|--------|------------------|------------|----------|
| 105161 | 250W MH/SB HPI-T | 2          | 78,80 \$ |
| 105173 | 400W SB SON-T    | 2          | 94,60 \$ |
| 105166 | 400W MH HPI-T    | 2          | 84,10 \$ |

**Elit Pesato 250-400W**  
Asimetrik Fiberglass

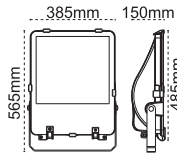

IP 65

| Kod No | Özellikler       | Koli Adedi | Fiyat    |
|--------|------------------|------------|----------|
| 105187 | 250W MH/SB HPI-T | 1          | 84,10 \$ |
| 105190 | 400W MH HPI-T    | 1          | 89,30 \$ |
| 105196 | 400W SB SON-T    | 1          | 99,80 \$ |

**Tünel 250-400W**  
Alüminyum Enjeksiyon

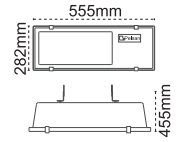

IP 65

| Kod No | Özellikler     | Koli Adedi | Fiyat     |
|--------|----------------|------------|-----------|
| 104327 | 250W MH/SB E40 | 1          | 154,40 \$ |
| 104329 | 400W SB E40    | 1          | 160,70 \$ |

**Elit Lirad 70-150W**  
Simetrik Fiberglass

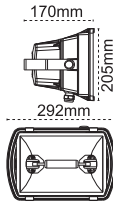

IP 65

| Kod No | Özellikler        | Koli Adedi | Fiyat    |
|--------|-------------------|------------|----------|
| 104320 | 70W MH/SB MHN-TD  | 6          | 48,10 \$ |
| 104323 | 150W MH/SB MHN-TD | 6          | 53,10 \$ |

**Elit Semiad 70-150W**  
Asimetrik Fiberglass

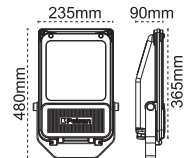

IP 65

| Kod No | Özellikler        | Koli Adedi | Fiyat    |
|--------|-------------------|------------|----------|
| 104308 | 70W MH/SB MHN-TD  | 4          | 48,10 \$ |
| 104311 | 150W MH/SB MHN-TD | 4          | 53,10 \$ |

**Sodyum Lambalar**

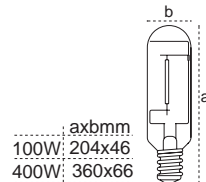

| Kod No | Özellikler     | Koli Adedi | Fiyat    |
|--------|----------------|------------|----------|
| 313506 | 100W 2000K E40 | 24         | 8,80 \$  |
| 313509 | 400W 2000K E40 | 24         | 13,10 \$ |

**Metal Lambalar**

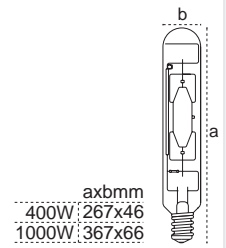

| Kod No | Özellikler      | Koli Adedi | Fiyat    |
|--------|-----------------|------------|----------|
| 313514 | 400W 5500K E40  | 24         | 13,10 \$ |
| 313512 | 1000W 5500K E40 | 20         | 45,00 \$ |

Uzun Ömürlü, Yüksek Verimli...

Gaziantep Kalesi LED Aydınlatması,  
Pelsan Aydınlatma M. Reşit Göğüş tarafından yapılmıştır.

- IP66 Toz ve Su Almaz
- Sararmaz, PMMA Lens
- IK08 Darbe Dayanımı
- Alüminyum Gövde



Hava Ventilli Rakor ile Nem Yapmaz!

S.Ü. Wallwasher  
IP66 Inovaled

ürün videosu



Renk Opsiyonları

- Mavi
- Yeşil
- Kırmızı
- Amber
- R G B

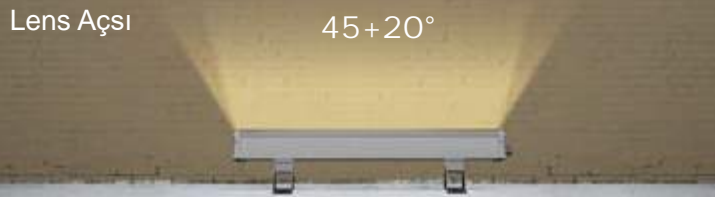

Mavi/Yeşil/Kırmızı/Amber  
Renk Fiyat Farkları

| Güç | Fiyat   |
|-----|---------|
| 10W | 9,00\$  |
| 15W | 12,50\$ |
| 30W | 25,00\$ |
| 45W | 41,70\$ |

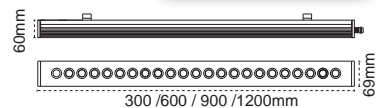

IP 66

IP 66

| Kod No | Özellikler                   | Koli Adedi | Fiyat    | Kod No | Özellikler                   | Koli Adedi | Fiyat    |
|--------|------------------------------|------------|----------|--------|------------------------------|------------|----------|
| 109731 | 10W 45+20 Derece 4000K 180mm | 1          | 31,30 \$ | 105517 | 30W 45+20 Derece 4000K 600mm | 1          | 62,40 \$ |
| 105508 | 15W 45+20 Derece 4000K 300mm | 1          | 41,70 \$ | 105525 | 45W 45+20 Derece 4000K 900mm | 1          | 93,50 \$ |

Madrid

Hem Ekonomik,  
Hem Verimli!



ürün  
videosu



129 lm/W  
Etkinlik Faktörü



129 lm/W Etkinlik Faktörü



4290 lm / 33W



ENEC Belgeli Sürücü



+50.000 Saat Sistem Ömrü

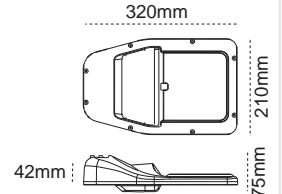
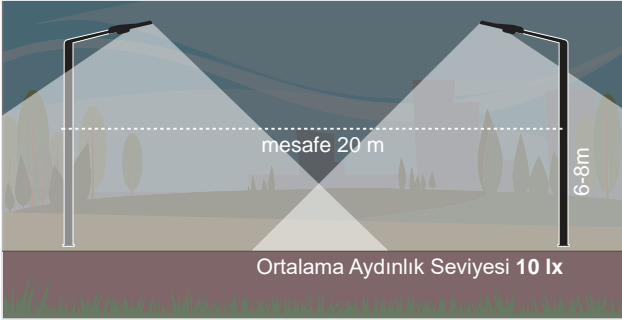

\* 129 lm/W Etkinlik Faktörüyle 50W LED Sokak Armatürü Işık Çıktısı Sunar.

IP 65 4000K 6500K

| Kod No | Özellikler | Koli Adedi | Fiyat    |
|--------|------------|------------|----------|
| 108494 | 33W 4000K  | 6          | 58,00 \$ |

Doka

Maksimum Performans İçin...

150 lm/W'a Varan  
Etkinlik Faktörü



Alüminyum Enjeksiyon Gövde



IP66 Toz ve Su Almaz!



ENEC Belgeli Driver @Tc - 70°C  
100.000 Saat Ömür



+54.000 Saat Ömür LED Çip

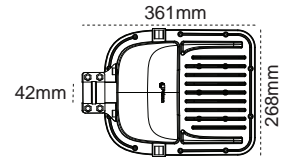

IP 66 4000K 6500K

| Kod No | Özellikler | Koli Adedi | Fiyat     |
|--------|------------|------------|-----------|
| 108943 | 50W 4000K  | 4          | 138,80 \$ |
| 108945 | 80W 4000K  | 4          | 141,80 \$ |
| 108947 | 100W 4000K | 4          | 141,80 \$ |

## Rio



-  +120 lm/W
-  LED Çip: L90 @105 °C 86.000 Saat Ömür
-  ENEC Belgeli LED Sürücü
-  -35 / +50 °C Çalışma Sıcaklığı
-  10 kV Yüksek Gerilim Koruması
-  IK10 Alüminyum Enjeksiyon Gövde
-  5 Farklı Konsol Açısı

 Gece Modu Opsiyonu  
 02:00'den Sonra Otomatik Dim

## Rio S IP66

65-150W



IP 66  4000K  6500K

| Kod No | Özellikler | Koli Adedi | Fiyat     |
|--------|------------|------------|-----------|
| 109214 | 65W 4000K  | 1          | 218,60 \$ |
| 109169 | 80W 4000K  | 1          | 245,90 \$ |
| 109171 | 100W 4000K | 1          | 245,90 \$ |
| 109173 | 125W 4000K | 1          | 255,70 \$ |
| 109175 | 150W 4000K | 1          | 255,70 \$ |

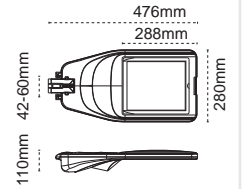

## Rio M IP66

180-220W



IP 66  4000K  6500K

| Kod No | Özellikler | Koli Adedi | Fiyat     |
|--------|------------|------------|-----------|
| 109183 | 180W 4000K | 1          | 405,10 \$ |
| 109185 | 200W 4000K | 1          | 405,10 \$ |
| 109187 | 220W 4000K | 1          | 405,10 \$ |

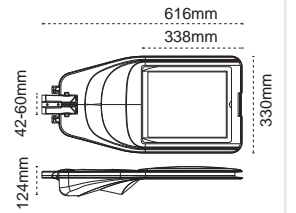

## Rio L IP66

240-300W



IP 66  4000K  6500K

| Kod No | Özellikler | Koli Adedi | Fiyat     |
|--------|------------|------------|-----------|
| 109194 | 240W 4000K | 1          | 562,60 \$ |
| 109196 | 270W 4000K | 1          | 562,60 \$ |
| 109198 | 300W 4000K | 1          | 562,60 \$ |

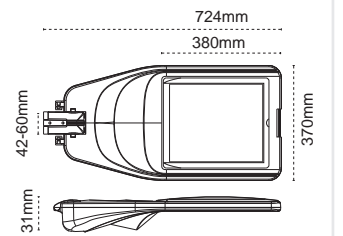

# Pelsan LEDli Yol Aydınlatma Armatürleri

**Talin**  
100W

CE

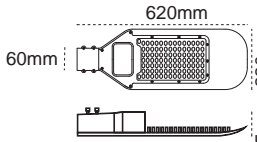



IP 65

| Kod No | Özellikler | Koli Adedi | Fiyat     |
|--------|------------|------------|-----------|
| 107994 | 100W 4000K | 4          | 135,50 \$ |

**Talin**  
150W

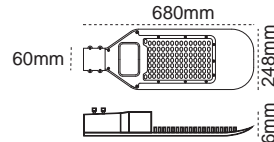
CE





IP 65

| Kod No | Özellikler | Koli Adedi | Fiyat     |
|--------|------------|------------|-----------|
| 109296 | 150W 4000K | 2          | 168,70 \$ |

**Talin**  
80W

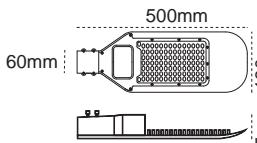
CE





IP 65

| Kod No | Özellikler | Koli Adedi | Fiyat     |
|--------|------------|------------|-----------|
| 108438 | 80W 4000K  | 4          | 104,50 \$ |

**Talin**  
50-30W

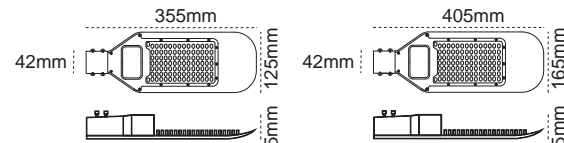
CE





IP 65

| Kod No | Özellikler | Koli Adedi | Fiyat    |
|--------|------------|------------|----------|
| 107993 | 50W 4000K  | 10         | 73,00 \$ |
| 107992 | 30W 4000K  | 15         | 43,10 \$ |

**Bari**  
100W

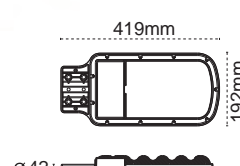
CE





IP 65

| Kod No | Özellikler | Koli Adedi | Fiyat     |
|--------|------------|------------|-----------|
| 109204 | 100W 4000K | 2          | 150,00 \$ |

**Lima**

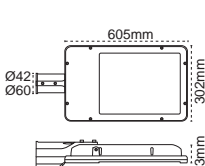
CE

IP 65

| Kod No | Özellikler | Koli Adedi | Fiyat     |
|--------|------------|------------|-----------|
| 105957 | 103W 4000K | 1          | 371,30 \$ |
| 105961 | 154W 4000K | 1          | 393,80 \$ |
| 105967 | 180W 4000K | 1          | 450,10 \$ |

## Roma Polimer Enjeksiyon

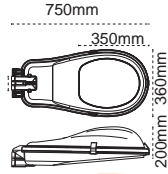

IP 66

| Kod No | Özellikler    | Koli Adedi | Fiyat     |
|--------|---------------|------------|-----------|
| 104102 | 250W SB SON-T | 2          | 106,10 \$ |
| 104105 | 400W SB SON-T | 2          | 117,90 \$ |

## Sofia Polimer Enjeksiyon

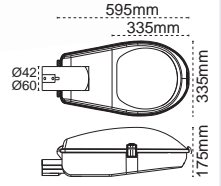

IP 65

| Kod No | Özellikler              | Koli Adedi | Fiyat    |
|--------|-------------------------|------------|----------|
| 104077 | Sofia 100W Sodyum SON-T | 2          | 63,60 \$ |
| 104081 | Sofia 150W Sodyum SON-T | 2          | 68,60 \$ |

## Riga Polimer Enjeksiyon

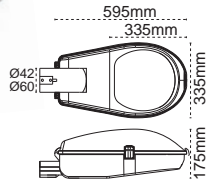

IP 65

| Kod No | Özellikler            | Koli Adedi | Fiyat    |
|--------|-----------------------|------------|----------|
| 104062 | Riga 50W Sodyum SON-T | 2          | 53,60 \$ |
| 104064 | Riga 70W Sodyum SON-T | 2          | 58,10 \$ |

## Lyon Alüminyum Enjeksiyon

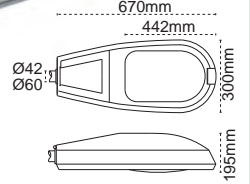

IP 65 / 43

| Kod No | Özellikler        | Koli Adedi | Fiyat     |
|--------|-------------------|------------|-----------|
| 103991 | 100W Sodyum SON-T | 1          | 176,10 \$ |
| 103992 | 150W Sodyum SON-T | 1          | 181,50 \$ |
| 103998 | 250W Sodyum SON-T | 1          | 203,40 \$ |
| 104007 | 400W Sodyum SON-T | 1          | 208,70 \$ |

## Ibiza / Corfu Fiberglass

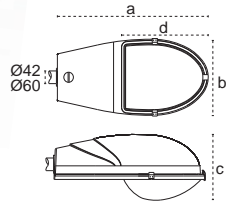

IP 54 / 43

| Kod No | Özellikler        | aXbXcXd mm      | Koli Adedi | Fiyat    |
|--------|-------------------|-----------------|------------|----------|
| 103952 | Boş E27           | 480X230X198X280 | 5          | 21,80 \$ |
| 103946 | 160W Boş E27      | 480X230X198X280 | 5          | 21,80 \$ |
| 103958 | 70W Son-T         | 480X230X198X280 | 5          | 45,20 \$ |
| 103823 | Boş E27           | 778X368X328X450 | 1          | 50,70 \$ |
| 103831 | 250W Sodyum SON-T | 778X368X328X450 | 1          | 85,10 \$ |
| 103842 | 400W Sodyum SON-T | 778X368X328X450 | 1          | 97,20 \$ |

## Bakü / Parma Temperli Camlı Alüminyum

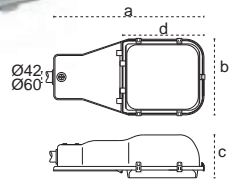

IP 65 / 43

| Kod No | Özellikler        | aXbXcXd mm      | Koli Adedi | Fiyat     |
|--------|-------------------|-----------------|------------|-----------|
| 103874 | 150W Sodyum SON-T | 625X315X245X340 | 1          | 91,90 \$  |
| 103877 | 250W Sodyum SON-T | 625X315X245X340 | 1          | 100,90 \$ |
| 103881 | 400W Sodyum SON-T | 625X315X245X340 | 1          | 105,30 \$ |
| 103790 | 160W Boş E27      | 570X280X195X300 | 5          | 45,20 \$  |
| 103796 | 150W Sodyum SON-T | 570X280X195X300 | 5          | 82,20 \$  |

## Aksesuarlar

| Kod No | Özellikler                      | Koli Adedi | Fiyat   |
|--------|---------------------------------|------------|---------|
| 311160 | Ø60 Direk Tipi Konsol Boru      | 1          | 9,00 \$ |
| 311157 | Set Üstü Konsol 60cm            | 1          | 9,00 \$ |
| 311156 | Duvar Tipi Konsol Boru 30cm Ø42 | 1          | 9,00 \$ |
| 311151 | Konsol Boru 60cm                | 1          | 4,90 \$ |

| Kod No | Özellikler                      | Koli Adedi | Fiyat   |
|--------|---------------------------------|------------|---------|
| 311155 | Duvar Tipi Konsol Boru 60cm Ø42 | 1          | 7,40 \$ |
| 311158 | Kelepçeli Konsol                | 1          | 7,40 \$ |
| 301125 | 60/42 Konsol Adaptörü           | 1          | 9,50 \$ |
| 310724 | Boru Kelepçe                    | 1          | 2,00 \$ |

Accra Solar



Doğadan Gelen Güç!



Accra Solar enerji hatlarının bulunmadığı alanlar için en ekonomik aydınlatma çözümüdür!

- 1 Kabloleme masrafı yok!
- 2 Elektrik masrafı yok!
- 3 Komple sistem çözümüdür! ( Batarya ve solar panel dahil)
- 4 Uzaktan kumanda ile kontrol edilebilir.
- 5 Gün içinde depoladığı enerji ile 2 gün aydınlatma sağlar.

Sensör Algılama Mesafesi

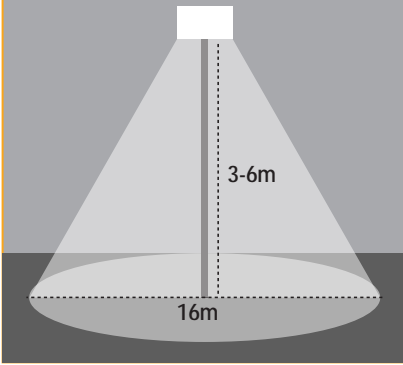

Kumanda ile Kontrol

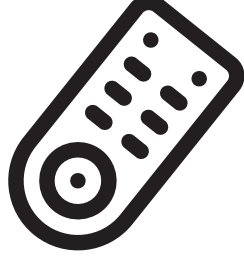

- 1 Mod 1: Radar sensörü aktif eder.
- 2 Mod 2: Radar sensör aktif değil. %50 yanar.
- 3 Mod 3: Kapalı
- 4 Mod 4: Zaman ayarı / Sürekli yanan mod



Etkinlik Alanları



Dağ Evleri



Kırsal Alanlar

40W Solar Aydınlatma Armatürü  
Accra

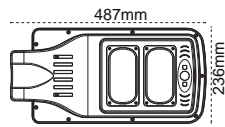

IP 65

| Kod No | Özellikler | Koli Adedi | Fiyat     |
|--------|------------|------------|-----------|
| 109431 | 40W 6500K  | 10         | 102,70 \$ |

60W Solar Aydınlatma Armatürü  
Accra

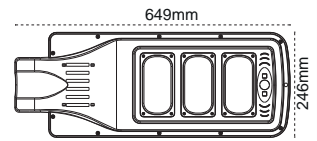

IP 65

| Kod No | Özellikler | Koli Adedi | Fiyat     |
|--------|------------|------------|-----------|
| 109432 | 60W 6500K  | 10         | 126,40 \$ |



## Mesaled

**W** 60W

**5260 lm**



**Alüminyum Gövde**

**Kamaşma Kontrollü Özel Difüzör**

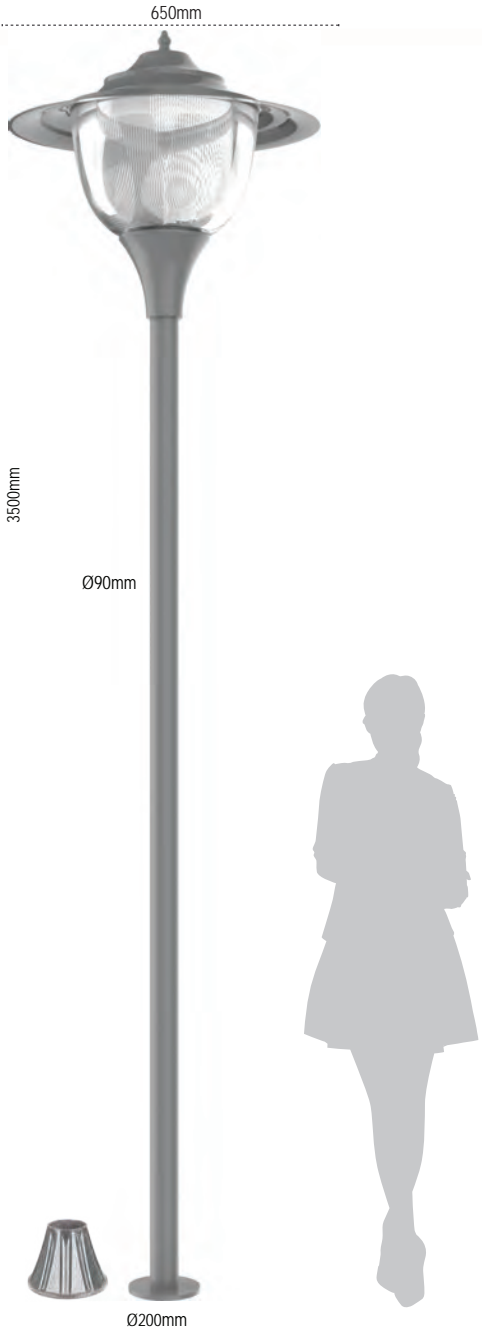
**Sok Fiyat**  
**301.30\$**



## Kamaşma kontrollü özel difüzör

-  Özel prizmatik difüzör
-  Kamaşma yapmayan optik dizayn
-  Yüksek ışık geçirgenliği

## Önerilen Uygulama Yüksekliği

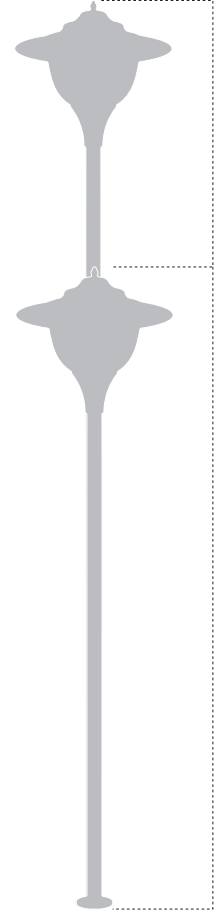

4-6 m

## Farklı RAL Kodu Uygulaması

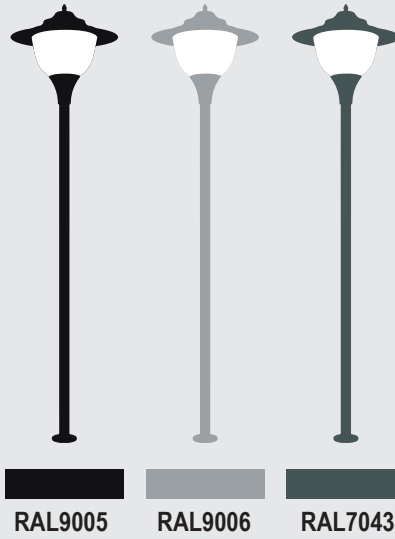

RAL9005

RAL9006

RAL7043

## Mesaled

IP 54

| Kod No | Özellikler | Koli Adedi | Fiyat     |
|--------|------------|------------|-----------|
| 108609 | 30W 4000K  | 1          | 259,30 \$ |
| 108608 | 60W 4000K  | 1          | 301,30 \$ |



# Pelsan LEDli Park Bahçe Aydınlatma Armatürleri

## Olimpos

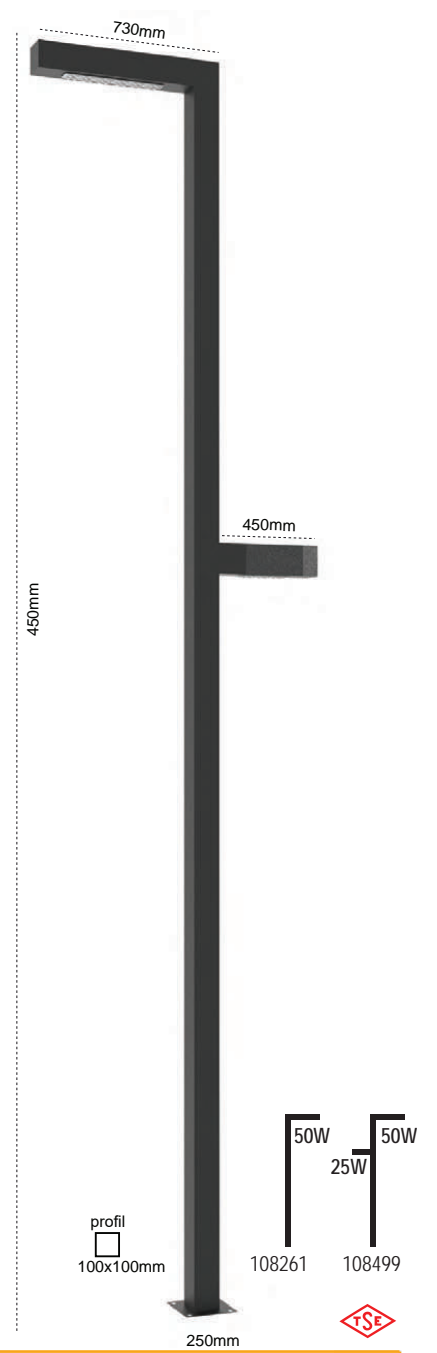
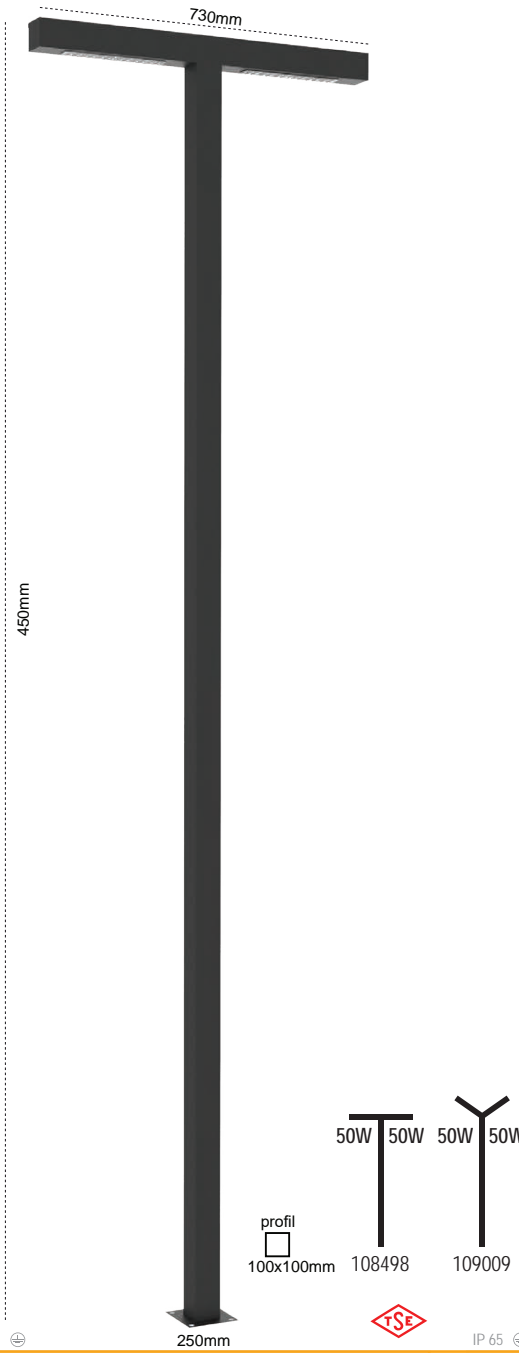

| Kod No | Özellikler   | Koli Adedi | Fiyat     |
|--------|--------------|------------|-----------|
| 107509 | 50 4000K     | 1          | 443,50 \$ |
| 108846 | 50+25W 4000K | 1          | 532,30 \$ |

| Kod No | Özellikler   | Koli Adedi | Fiyat     |
|--------|--------------|------------|-----------|
| 108498 | 50+50W 4000K | 1          | 621,10 \$ |
| 109009 | 50+50W 4000K | 1          | 621,10 \$ |

| Kod No | Özellikler   | Koli Adedi | Fiyat     |
|--------|--------------|------------|-----------|
| 108261 | 50 4000K     | 1          | 443,50 \$ |
| 108499 | 50+25W 4000K | 1          | 532,30 \$ |

**Palmira**

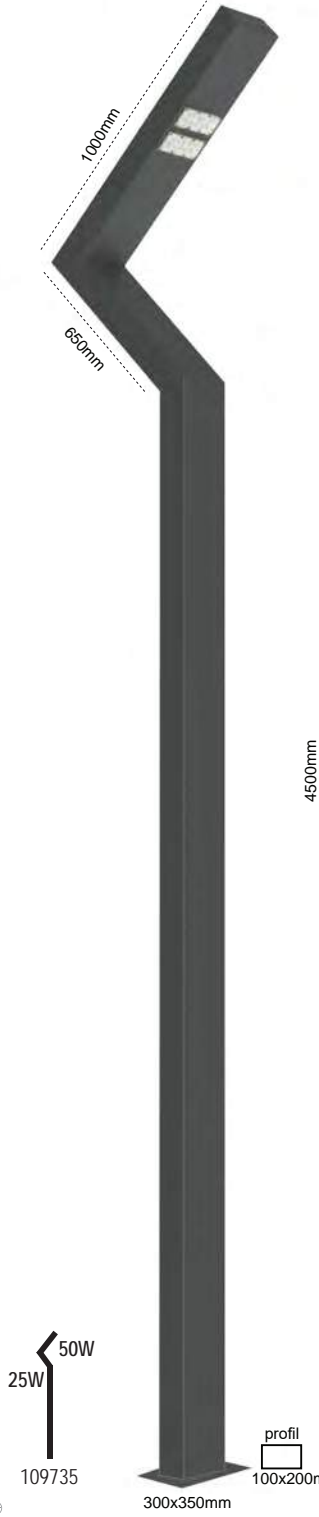

IP 65

109735

300x350mm

profil

100x200mm

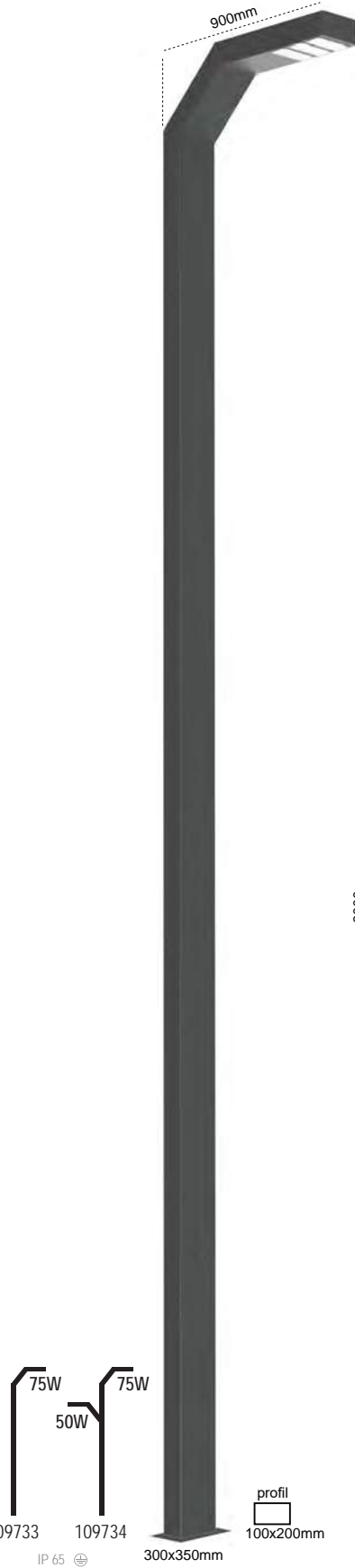

IP 65

109733

109734

300x350mm

profil

100x200mm

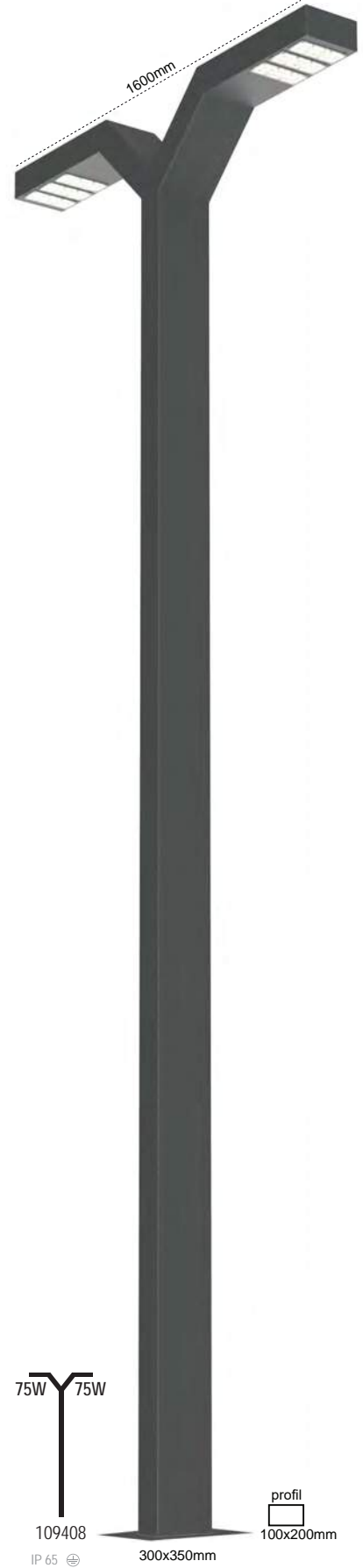

IP 65

109408

300x350mm

profil

100x200mm



| Kod No | Özellikler   | Koli Adedi | Fiyat     |
|--------|--------------|------------|-----------|
| 109735 | 50+25W 4000K | 1          | 798,10 \$ |

| Kod No | Özellikler   | Koli Adedi | Fiyat       |
|--------|--------------|------------|-------------|
| 109733 | 75W 4000K    | 1          | 912,10 \$   |
| 109734 | 50+75W 4000K | 1          | 1.110,10 \$ |

| Kod No | Özellikler   | Koli Adedi | Fiyat       |
|--------|--------------|------------|-------------|
| 109408 | 75+75W 4000K | 1          | 1.240,90 \$ |

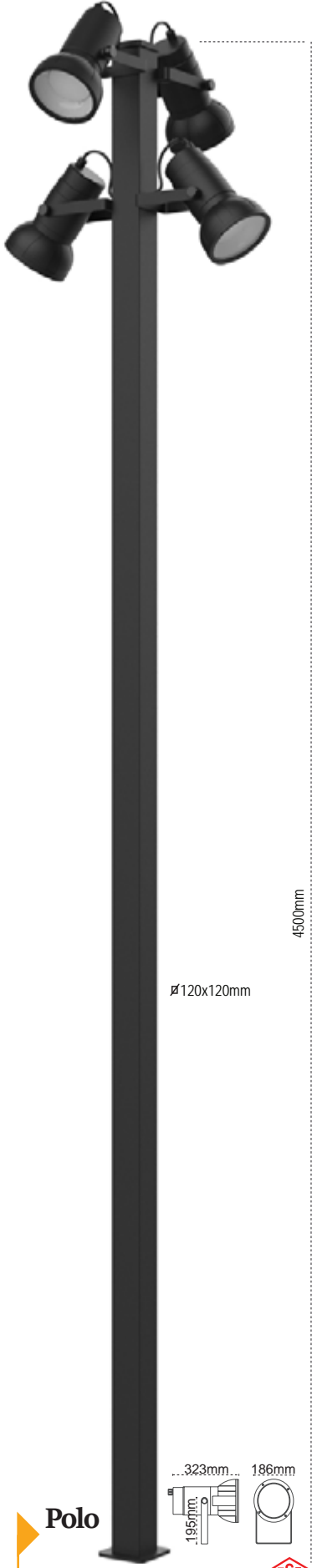

| Kod No | Özellikler  | Koli Adedi | Fiyat     |
|--------|-------------|------------|-----------|
| 109660 | 4x25W 4000K | 1          | 888,10 \$ |

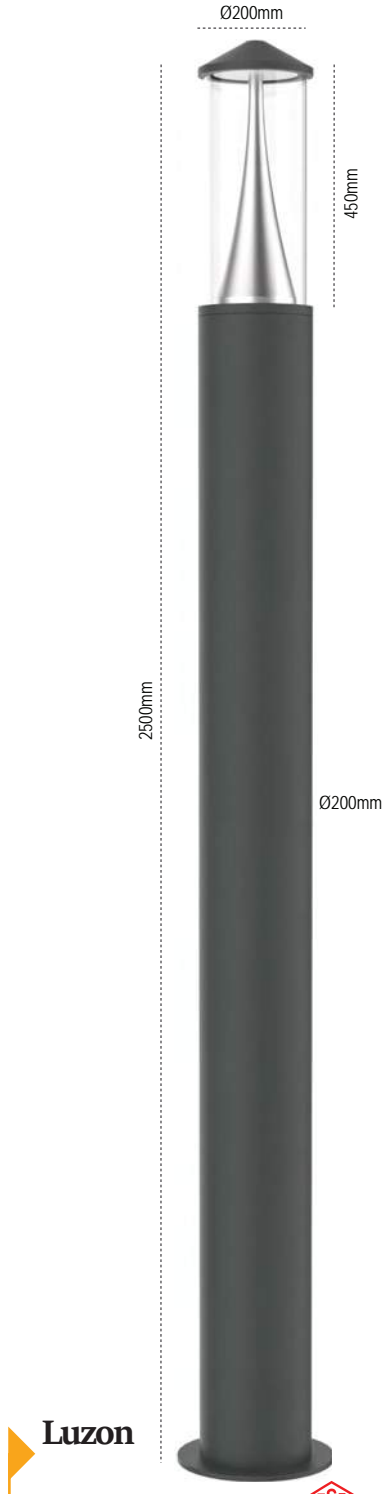

| Kod No | Özellikler | Koli Adedi | Fiyat     |
|--------|------------|------------|-----------|
| 109736 | 40W 4000K  | 1          | 444,10 \$ |

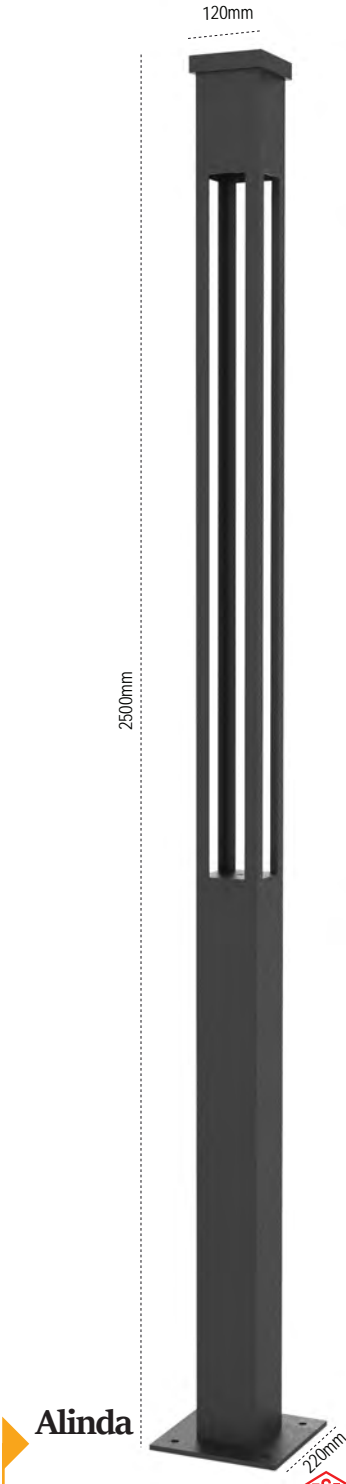

| Kod No | Özellikler | Koli Adedi | Fiyat     |
|--------|------------|------------|-----------|
| 107467 | 35W 4000K  | 1          | 276,10 \$ |

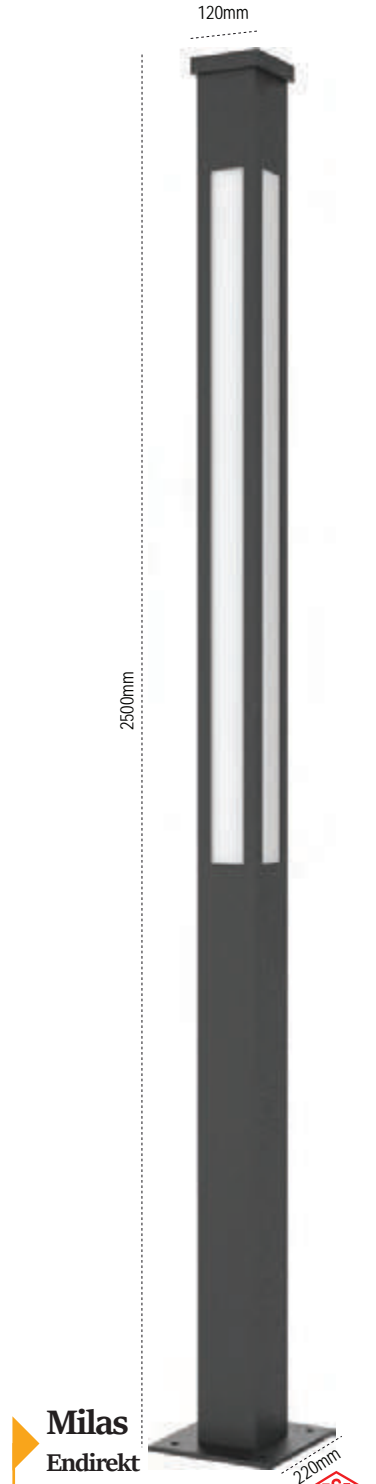

| Kod No | Özellikler | Koli Adedi | Fiyat     |
|--------|------------|------------|-----------|
| 108500 | 100W 4000K | 1          | 690,10 \$ |

Yeni\*

# LEDli Park Bahçe Aydınlatma Armatürleri

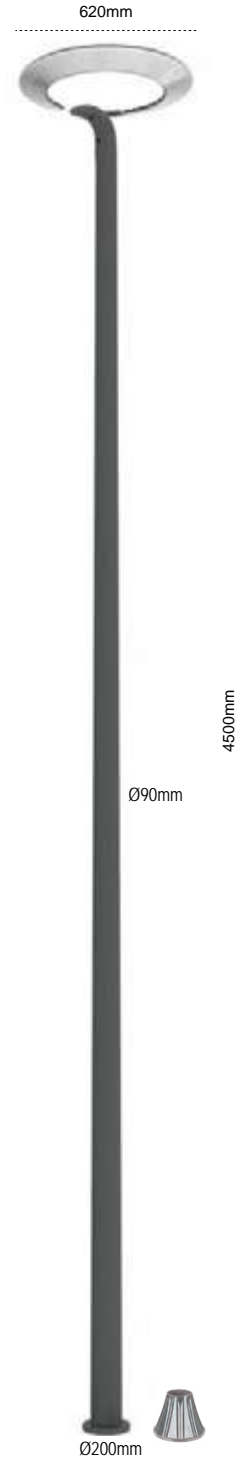
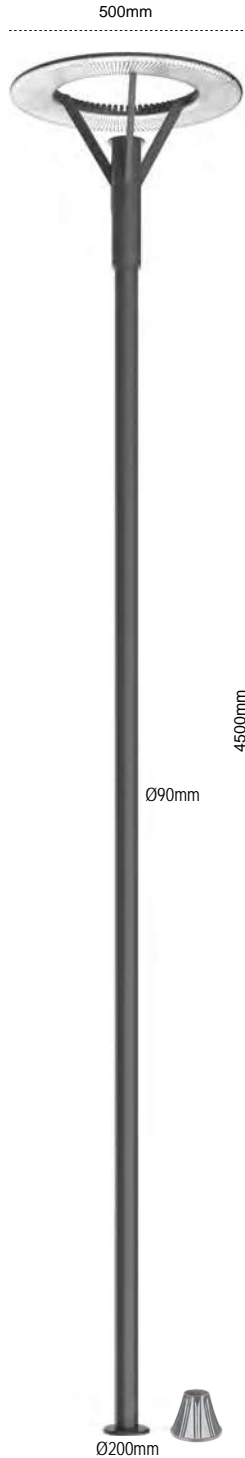

## Troya

IP 65

Kod No Özellikler  
109742 60W 4000K

Koli Adedi Fiyat  
1 468,10 \$



## Aperla

IP 65

Kod No Özellikler  
109741 60W 4000K

Koli Adedi Fiyat  
1 492,10 \$



# Pelsan LEDli Park Bahçe Aydınlatma Armatürleri



754mm



700mm



710mm



500mm

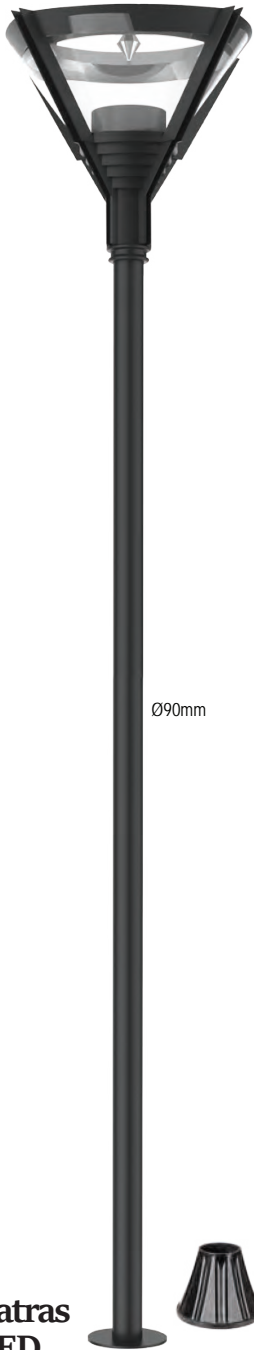

Ø90mm

4500mm

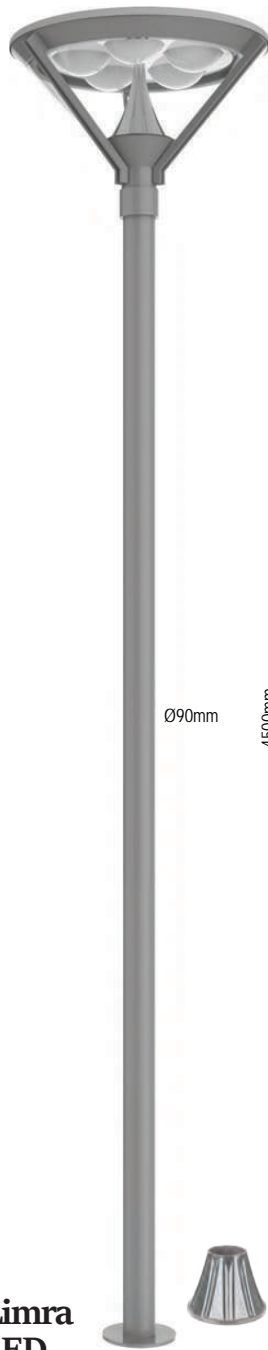

Ø90mm

4500mm

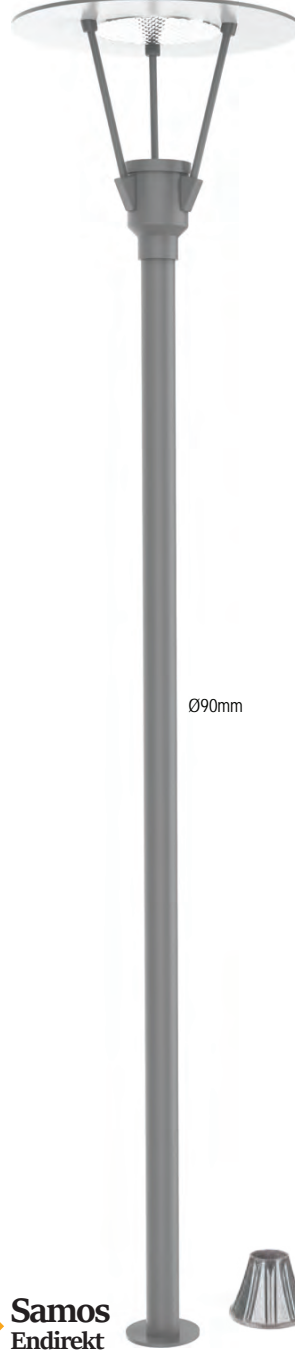

Ø90mm

4500mm

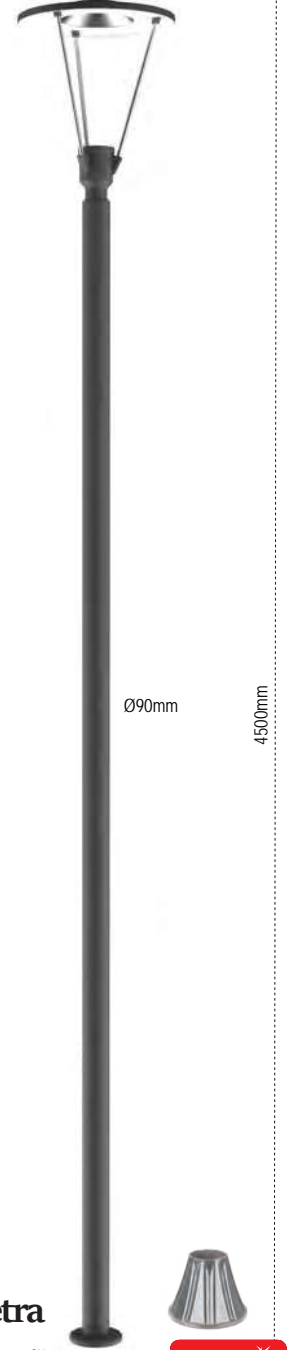

Ø90mm

4500mm

## Patras LED

IP 65

Ø250mm



| Kod No | Özellikler    | Koli Adedi | Fiyat     |
|--------|---------------|------------|-----------|
| 107439 | 68W LED 4000K | 1          | 600,10 \$ |

## Limra LED

IP 54

Ø250mm



| Kod No | Özellikler         | Koli Adedi | Fiyat     |
|--------|--------------------|------------|-----------|
| 107416 | 150W E40           | 1          | 360,10 \$ |
| 108606 | 38W LED 4000K 3'lü | 1          | 480,10 \$ |
| 108605 | 80W LED 4000K 5'li | 1          | 624,10 \$ |

## Samos Endirekt

IP 65

Ø250mm



| Kod No | Özellikler    | Koli Adedi | Fiyat     |
|--------|---------------|------------|-----------|
| 108612 | 150W G12      | 1          | 480,10 \$ |
| 108163 | 50W LED 4000K | 1          | 570,10 \$ |

## Petra

IP 65

Ø250mm



**Yeni\***

| Kod No | Özellikler | Koli Adedi | Fiyat     |
|--------|------------|------------|-----------|
| 107882 | 50W 4000K  | 1          | 390,10 \$ |

# LEDli Park Bahçe Aydınlatma Armatürleri

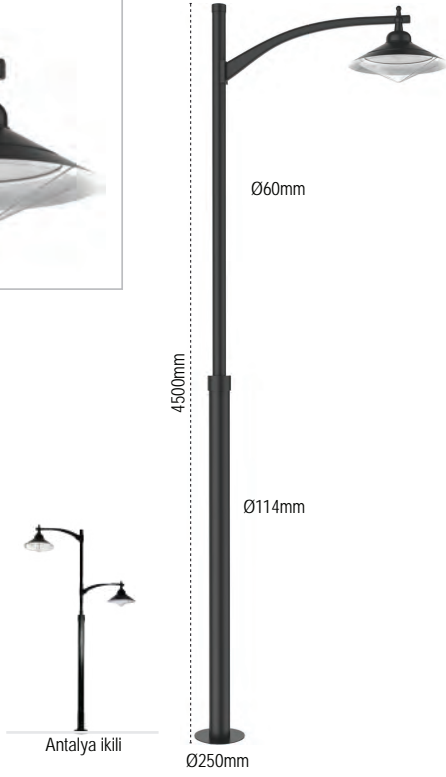

## Antalya

IP 54

| Kod No | Özellikler      | Koli Adedi | Fiyat     |
|--------|-----------------|------------|-----------|
| 107531 | Tekli Direk E27 | 1          | 230,70 \$ |
| 107532 | İkili Direk E27 | 1          | 293,70 \$ |

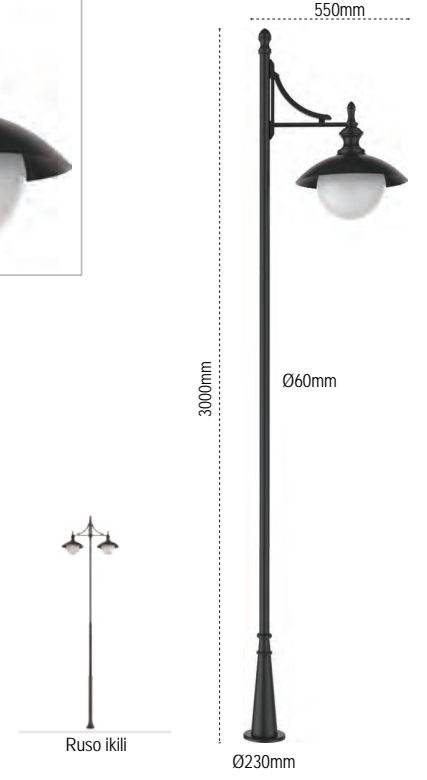

## Ruso

IP 54

| Kod No | Özellikler                  | Koli Adedi | Fiyat     |
|--------|-----------------------------|------------|-----------|
| 107461 | Tekli Döküm Dipli Direk E27 | 1          | 239,70 \$ |
| 107463 | İkili Döküm Dipli Direk E27 | 1          | 320,70 \$ |

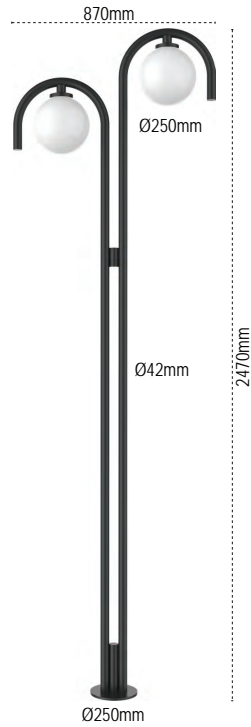

## Perge

IP 54

| Kod No | Özellikler | Koli Adedi | Fiyat     |
|--------|------------|------------|-----------|
| 107543 | İkili E27  | 1          | 165,40 \$ |

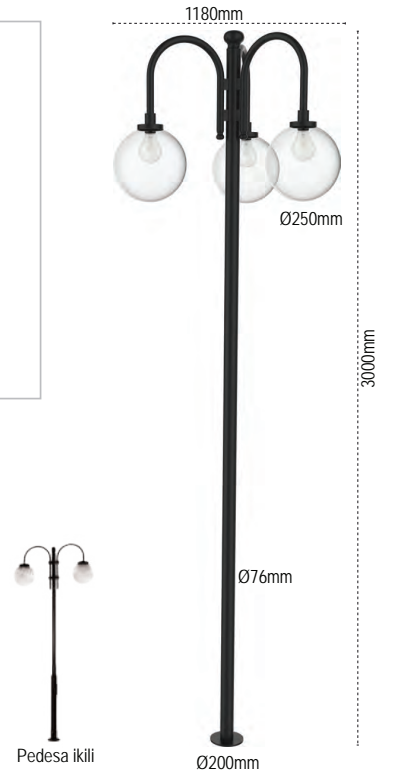

## Pedesa

IP 54

| Kod No | Özellikler             | Koli Adedi | Fiyat     |
|--------|------------------------|------------|-----------|
| 107533 | Tekli Gloplu Direk E27 | 1          | 120,40 \$ |
| 107517 | İkili Gloplu Direk E27 | 1          | 200,30 \$ |
| 107530 | Üçlü Gloplu Direk E27  | 1          | 284,70 \$ |

# Pelsan LEDli Park Bahçe Aydınlatma Armatürleri

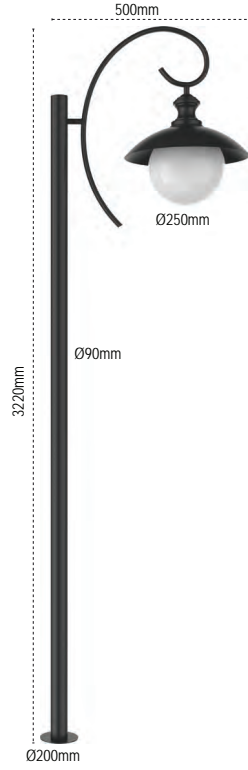

## Uruse

IP 54

| Kod No | Özellikler | Koli Adedi | Fiyat     |
|--------|------------|------------|-----------|
| 107510 | Tekli E27  | 1          | 157,60 \$ |

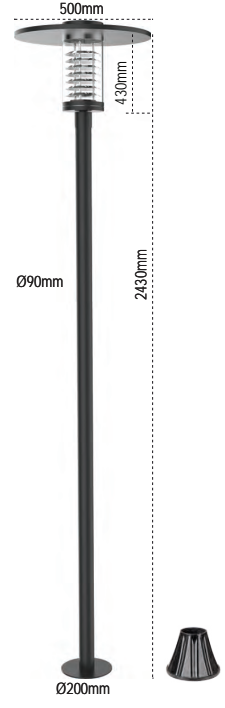

## Arta

IP 54

| Kod No | Özellikler               | Koli Adedi | Fiyat     |
|--------|--------------------------|------------|-----------|
| 107591 | Arta Boru Direk Arm. E27 | 1          | 258,80 \$ |

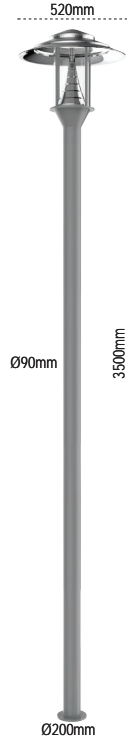

## Eualed

IP 54

| Kod No | Özellikler    | Koli Adedi | Fiyat     |
|--------|---------------|------------|-----------|
| 108610 | 40W LED 4000K | 1          | 453,70 \$ |

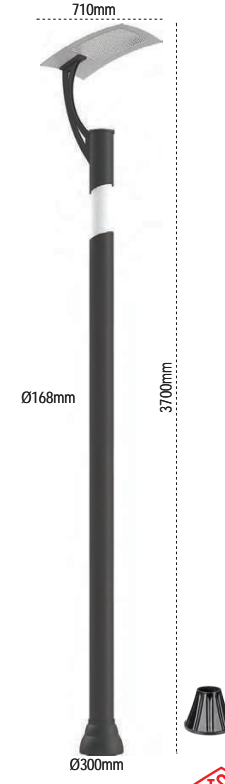

## Datça

IP 54

| Kod No | Özellikler         | Koli Adedi | Fiyat     |
|--------|--------------------|------------|-----------|
| 107619 | 150W G12           | 1          | 480,10 \$ |
| 107601 | 30W LED 4000K      | 1          | 600,10 \$ |
| 313768 | RGB Kontrol Cihazı | 1          | 11,30 \$  |



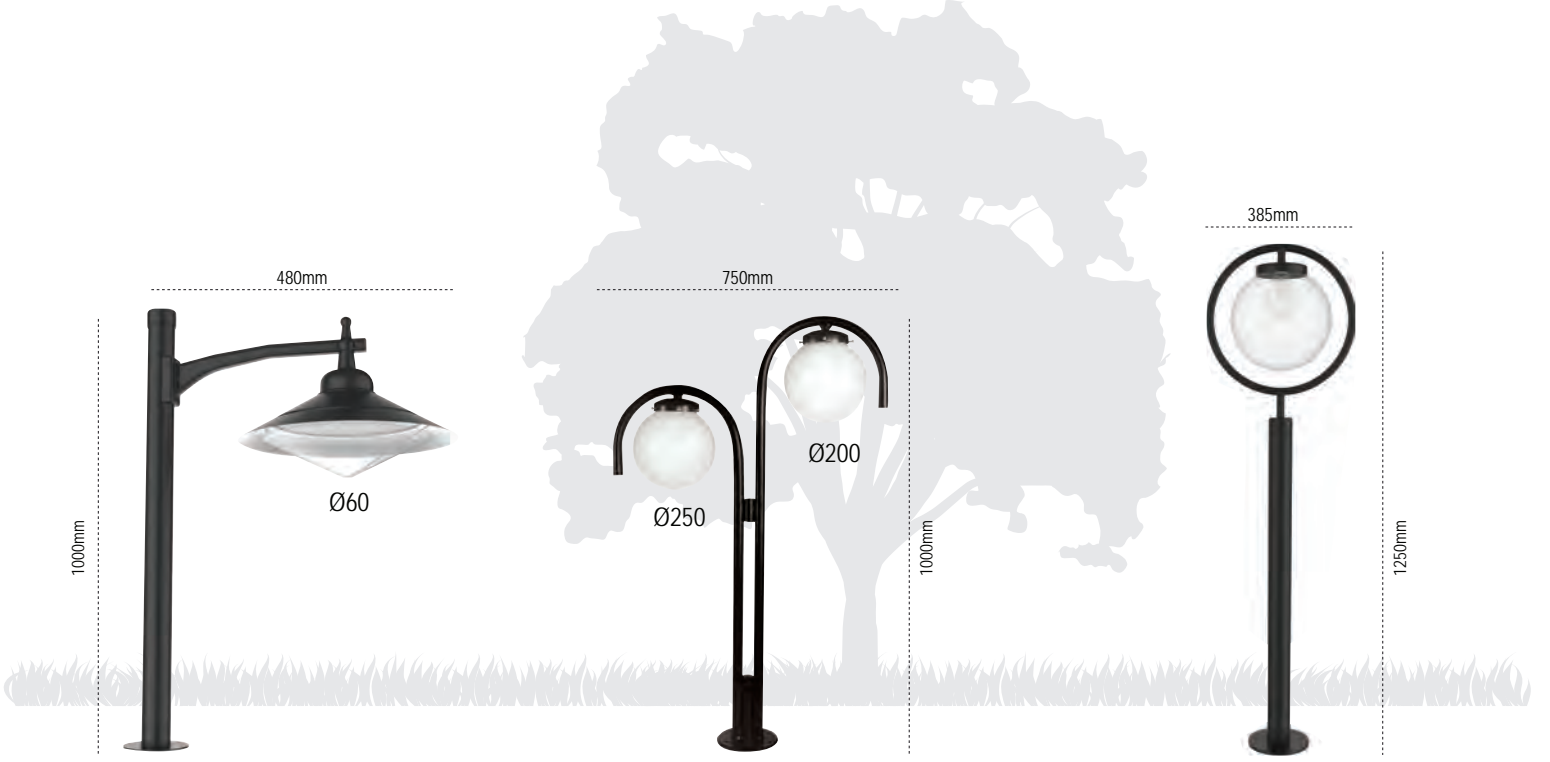

## Antalya

IP 54 ☺

| Kod No | Özellikler | Koli Adedi | Fiyat    |
|--------|------------|------------|----------|
| 107588 | E27 Duyulu | 1          | 90,10 \$ |

## Perge

IP 54 ☺

| Kod No | Özellikler | Koli Adedi | Fiyat    |
|--------|------------|------------|----------|
| 107585 | E27 Duyulu | 1          | 52,10 \$ |

## Pedesa

IP 54 ☺

| Kod No | Özellikler | Koli Adedi | Fiyat    |
|--------|------------|------------|----------|
| 107564 | E27 Duyulu | 1          | 52,10 \$ |

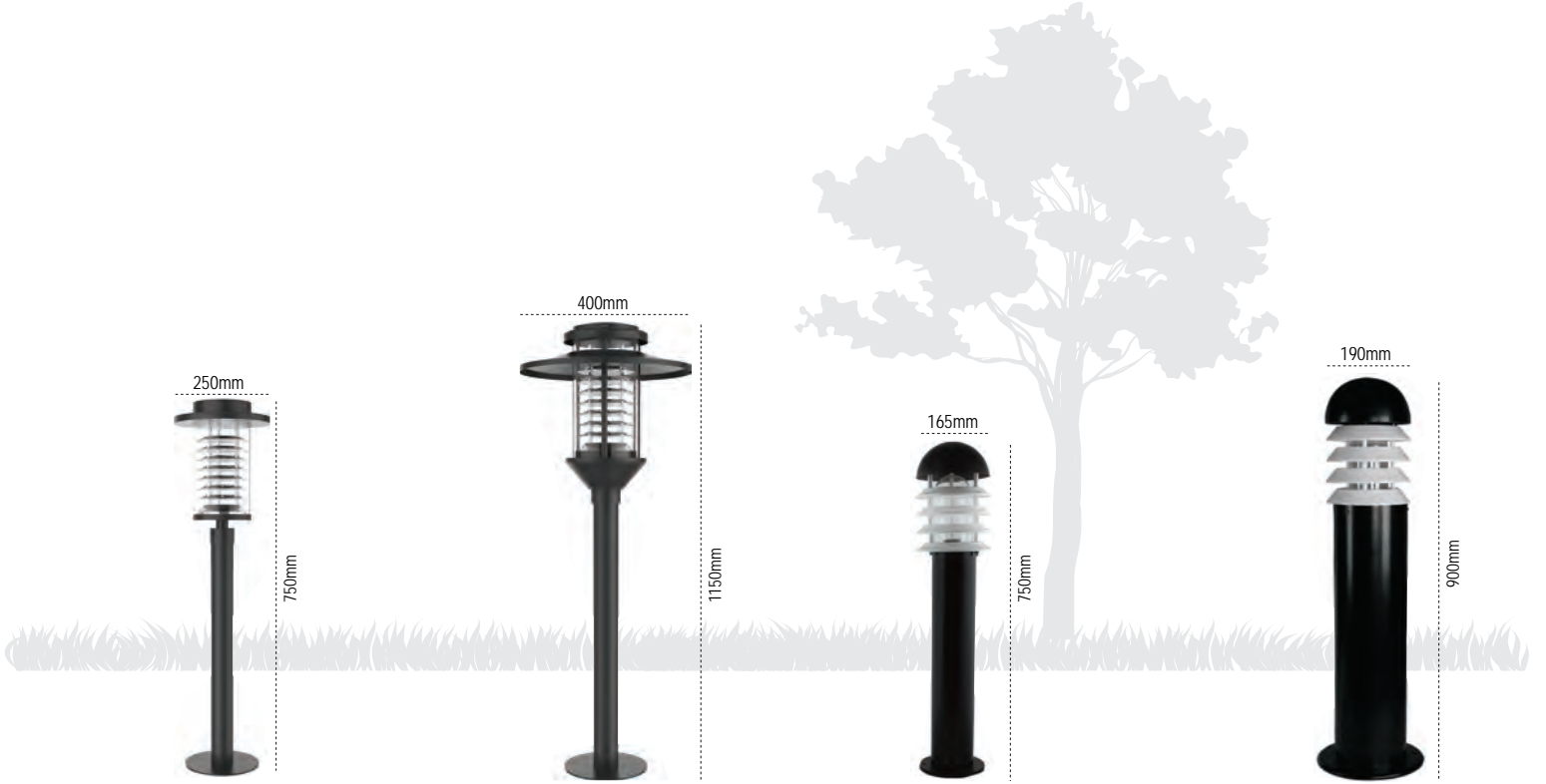

## Arta

IP 54 ☺

| Kod No | Özellikler | Koli Adedi | Fiyat    |
|--------|------------|------------|----------|
| 107565 | E27 Duyulu | 1          | 83,20 \$ |

## Eva

IP 54 ☺

| Kod No | Özellikler | Koli Adedi | Fiyat     |
|--------|------------|------------|-----------|
| 107560 | E27 Duyulu | 1          | 103,90 \$ |

## Noa

IP 54 ☺

| Kod No | Özellikler | Koli Adedi | Fiyat    |
|--------|------------|------------|----------|
| 107578 | E27 Duyulu | 1          | 41,30 \$ |

## Fia

IP 54 ☺

| Kod No | Özellikler | Koli Adedi | Fiyat    |
|--------|------------|------------|----------|
| 107557 | E27 Duyulu | 1          | 93,50 \$ |



### Alcatra

IP 65 ☹

| Kod No | Özellikler | Koli Adedi | Fiyat     |
|--------|------------|------------|-----------|
| 108856 | 18W 4000K  | 1          | 133,30 \$ |

### Dominik

IP 65 ☹

| Kod No | Özellikler  | Koli Adedi | Fiyat     |
|--------|-------------|------------|-----------|
| 108866 | 2x18W 4000K | 1          | 177,40 \$ |

### Tahiti

IP 65 ☹

| Kod No | Özellikler | Koli Adedi | Fiyat     |
|--------|------------|------------|-----------|
| 108868 | 18W 4000K  | 1          | 133,30 \$ |

### Mikanos

IP 65 ☹

| Kod No | Özellikler  | Koli Adedi | Fiyat     |
|--------|-------------|------------|-----------|
| 108869 | 2x18W 4000K | 1          | 177,40 \$ |



### Bali

IP 65 ☹

| Kod No | Özellikler | Koli Adedi | Fiyat     |
|--------|------------|------------|-----------|
| 108870 | 18W 4000K  | 1          | 133,30 \$ |

### Malta

IP 65 ☹

| Kod No | Özellikler  | Koli Adedi | Fiyat     |
|--------|-------------|------------|-----------|
| 108871 | 2x18W 4000K | 1          | 177,40 \$ |

### Maldiv

IP 65 ☹

| Kod No | Özellikler | Koli Adedi | Fiyat     |
|--------|------------|------------|-----------|
| 108872 | 18W 4000K  | 1          | 133,30 \$ |

### Santorini

IP 65 ☹

| Kod No | Özellikler  | Koli Adedi | Fiyat     |
|--------|-------------|------------|-----------|
| 108873 | 2x18W 4000K | 1          | 177,40 \$ |



### Pega

| IP 65 ☺ |            |            |           |
|---------|------------|------------|-----------|
| Kod No  | Özellikler | Koli Adedi | Fiyat     |
| 108878  | 18W 4000K  | 1          | 111,10 \$ |

### Alinda

| IP 65 ☺ |            |            |           |
|---------|------------|------------|-----------|
| Kod No  | Özellikler | Koli Adedi | Fiyat     |
| 108859  | 18W 4000K  | 1          | 111,10 \$ |

### Luzon

| IP 65 ☺ |            |            |           |
|---------|------------|------------|-----------|
| Kod No  | Özellikler | Koli Adedi | Fiyat     |
| 109027  | 20W 4000K  | 1          | 133,30 \$ |

### Milas

| IP 54 ☺ |            |            |           |
|---------|------------|------------|-----------|
| Kod No  | Özellikler | Koli Adedi | Fiyat     |
| 107580  | E27 Duyulu | 1          | 154,90 \$ |
| 107586  | 20W 4000K  | 1          | 242,50 \$ |



### Hawaii

| IP 65 ☺ |            |            |           |
|---------|------------|------------|-----------|
| Kod No  | Özellikler | Koli Adedi | Fiyat     |
| 108874  | 20W 4000K  | 1          | 133,30 \$ |

### Bahama

| IP 65 ☺ |             |            |           |
|---------|-------------|------------|-----------|
| Kod No  | Özellikler  | Koli Adedi | Fiyat     |
| 108875  | 2x20W 4000K | 1          | 177,40 \$ |

### Capri

| IP 65 ☺ |            |            |           |
|---------|------------|------------|-----------|
| Kod No  | Özellikler | Koli Adedi | Fiyat     |
| 108876  | 20W 4000K  | 1          | 133,30 \$ |

### Phuket

| IP 65 ☺ |             |            |           |
|---------|-------------|------------|-----------|
| Kod No  | Özellikler  | Koli Adedi | Fiyat     |
| 108877  | 2x20W 4000K | 1          | 177,40 \$ |

**Mova Sensörlü**

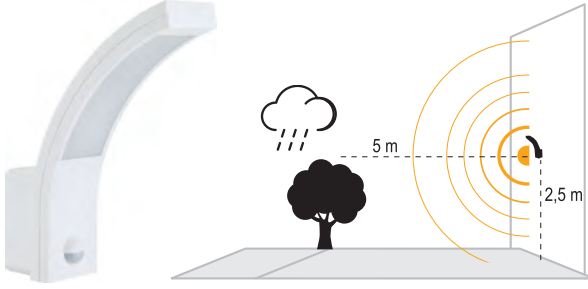

IP 54 ☹

| Kod No | Özellikler | Koli Adedi | Fiyat    |
|--------|------------|------------|----------|
| 109228 | 10W 6500K  | 10         | 28,50 \$ |

**Işıközü Sensörlü**

Alüminyum Enjeksiyon

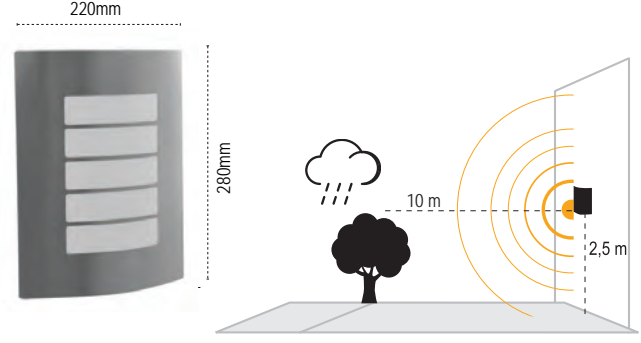

IP 44 ☹

| Kod No | Özellikler | Koli Adedi | Fiyat    |
|--------|------------|------------|----------|
| 109297 | E27 Duyulu | 10         | 40,00 \$ |

**Işılay 1**

Alüminyum Enjeksiyon

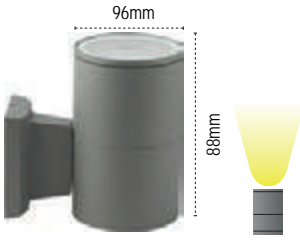

IP 54 ☹

| Kod No | Özellikler | Koli Adedi | Fiyat    |
|--------|------------|------------|----------|
| 204505 | 10W 6500K  | 18         | 32,50 \$ |

**Işılay 2**

Alüminyum Enjeksiyon



IP 54 ☹

| Kod No | Özellikler   | Koli Adedi | Fiyat    |
|--------|--------------|------------|----------|
| 204506 | 2xE27 Duyulu | 12         | 37,30 \$ |

**Altıgen Aplik**



IP 54 ☹

| Kod No | Özellikler | Koli Adedi | Fiyat   |
|--------|------------|------------|---------|
| 109771 | E27 Duyulu | 18         | 8,20 \$ |

**Zeugma Aplik Bakıroksit**



IP 54 ☹

| Kod No | Özellikler | Koli Adedi | Fiyat   |
|--------|------------|------------|---------|
| 199773 | E27 Duyulu | 27         | 9,80 \$ |

### Arta

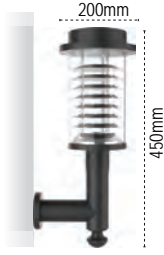

IP 54

| Kod No | Özellikler | Koli Adedi | Fiyat    |
|--------|------------|------------|----------|
| 107410 | E27 Duylu  | 1          | 84,10 \$ |

### Eva



IP 54

| Kod No | Özellikler | Koli Adedi | Fiyat    |
|--------|------------|------------|----------|
| 107411 | E27 Duylu  | 1          | 94,60 \$ |

### Ruso



IP 54

| Kod No | Özellikler | Koli Adedi | Fiyat    |
|--------|------------|------------|----------|
| 107393 | E27 Duylu  | 1          | 47,30 \$ |

### Uruse



IP 54

| Kod No | Özellikler | Koli Adedi | Fiyat    |
|--------|------------|------------|----------|
| 107395 | E27 Duylu  | 1          | 52,60 \$ |

### Perge



IP 54

| Kod No | Özellikler | Koli Adedi | Fiyat    |
|--------|------------|------------|----------|
| 107391 | E27 Duylu  | 1          | 42,10 \$ |

### Antalya



IP 54

| Kod No | Özellikler | Koli Adedi | Fiyat    |
|--------|------------|------------|----------|
| 107409 | E27 Duylu  | 1          | 63,10 \$ |

### Işiled 2

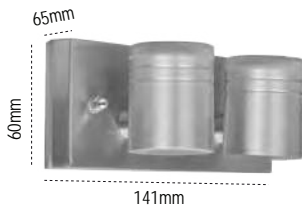

IP 44

| Kod No | Özellikler       | Koli Adedi | Fiyat   |
|--------|------------------|------------|---------|
| 204473 | LEDli Ilık Beyaz | 2          | 9,60 \$ |
| 204472 | LEDli Mavi       | 2          | 9,60 \$ |

### Doraled

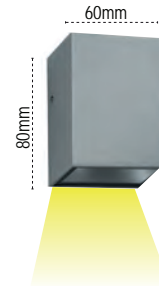

Alüminyum  
Enjeksiyon

IP 54

| Kod No | Özellikler | Koli Adedi | Fiyat    |
|--------|------------|------------|----------|
| 204529 | 3W 4000K   | 24         | 18,10 \$ |

**Cubo**

Alüminyum Enjeksiyon

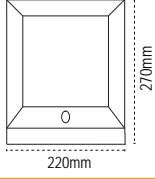
IP 54

| Kod No | Özellikler | Koli Adedi | Fiyat    |
|--------|------------|------------|----------|
| 204423 | E27        | 6          | 60,10 \$ |

**Alinda**



IP 54

| Kod No | Özellikler | Koli Adedi | Fiyat    |
|--------|------------|------------|----------|
| 109401 | 15W 4000K  | 1          | 93,50 \$ |

**Tura**

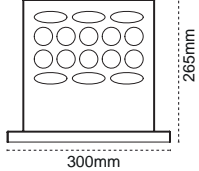
IP 54

| Kod No | Özellikler   | Koli Adedi | Fiyat     |
|--------|--------------|------------|-----------|
| 109445 | 4xE27 Duyulu | 1          | 145,50 \$ |

**Tino**



IP 54

| Kod No | Özellikler | Koli Adedi | Fiyat    |
|--------|------------|------------|----------|
| 109404 | E27 Duyulu | 1          | 38,80 \$ |

**Vedra**

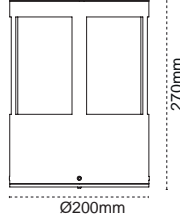
IP 54

| Kod No | Özellikler   | Koli Adedi | Fiyat     |
|--------|--------------|------------|-----------|
| 109444 | 4xE27 Duyulu | 1          | 122,40 \$ |

**Canaria**

IP 54

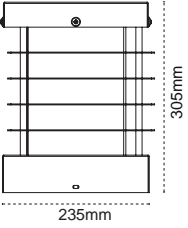
| Kod No | Özellikler   | Koli Adedi | Fiyat     |
|--------|--------------|------------|-----------|
| 109423 | 4xE27 Duyulu | 1          | 106,90 \$ |

**Elba**



IP 54

| Kod No | Özellikler   | Koli Adedi | Fiyat    |
|--------|--------------|------------|----------|
| 109437 | 4xE27 Duyulu | 1          | 97,20 \$ |

**Hawaii**

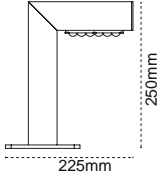
IP 65

| Kod No | Özellikler | Koli Adedi | Fiyat    |
|--------|------------|------------|----------|
| 109438 | 15W 4000K  | 1          | 95,70 \$ |

### Luzon

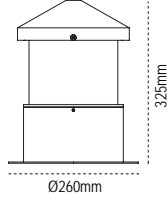

IP 65

| Kod No | Özellikler | Koli Adedi | Fiyat    |
|--------|------------|------------|----------|
| 109402 | 15W 4000K  | 1          | 97,70 \$ |

### Pega

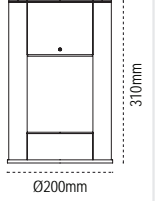

IP 65

| Kod No | Özellikler | Koli Adedi | Fiyat    |
|--------|------------|------------|----------|
| 109403 | 15W 4000K  | 2          | 87,50 \$ |

### Arta

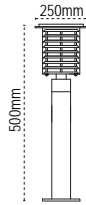

IP 54

| Kod No | Özellikler | Koli Adedi | Fiyat    |
|--------|------------|------------|----------|
| 107447 | E27 Duylu  | 6          | 87,30 \$ |

### Eva

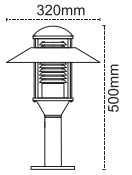

IP 54

| Kod No | Özellikler | Koli Adedi | Fiyat    |
|--------|------------|------------|----------|
| 107453 | E27 Duylu  | 6          | 81,60 \$ |

### Altıgen Set Üstü

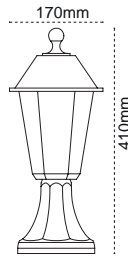

IP 54

| Kod No | Özellikler | Koli Adedi | Fiyat   |
|--------|------------|------------|---------|
| 109772 | E27 Duylu  | 18         | 8,20 \$ |

### Zeugma Set Üstü

#### Bakıroksit

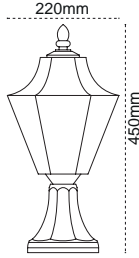

IP 54

| Kod No | Özellikler | Koli Adedi | Fiyat   |
|--------|------------|------------|---------|
| 109774 | E27 Duylu  | 27         | 9,80 \$ |

### Altıgen Aplik

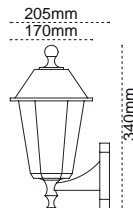

IP 54

| Kod No | Özellikler | Koli Adedi | Fiyat   |
|--------|------------|------------|---------|
| 109771 | E27 Duylu  | 18         | 8,20 \$ |

### Zeugma Aplik

#### Bakıroksit

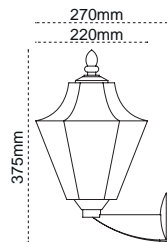

IP 54

| Kod No | Özellikler | Koli Adedi | Fiyat   |
|--------|------------|------------|---------|
| 109773 | E27 Duylu  | 27         | 9,80 \$ |

**Yeni Ürün**

**20- 10W Dış Mekan Spotu**  
Erbaled

- 6500K
- 4000K
- 3000K
- Amber
- Yeşil
- Mavi
- Kırmızı



20W 10W

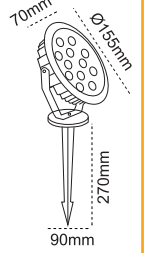

IP 65

| Kod No | Özellikler           | Koli Adedi | Fiyat    |
|--------|----------------------|------------|----------|
| 108004 | 20W 6500K            | 10         | 41,60 \$ |
| 204261 | Saplama Aparatı 21cm | 1          | 4,60 \$  |

| Kod No | Özellikler           | Koli Adedi | Fiyat    |
|--------|----------------------|------------|----------|
| 109359 | 10W 4000K            | 10         | 41,60 \$ |
| 109485 | 10W Yeşil            | 10         | 41,60 \$ |
| 205288 | Saplama Aparatı 21cm | 1          | 4,60 \$  |

**3W Dış Mekan Spotu**  
Grassled

Alüminyum  
Enjeksiyon

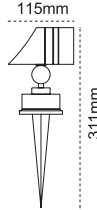

IP 65

| Kod No | Özellikler      | Koli Adedi | Fiyat    |
|--------|-----------------|------------|----------|
| 203813 | 3W 6500K        | 20         | 16,80 \$ |
| 203816 | 3W Yeşil        | 20         | 16,80 \$ |
| 203814 | Saplama Aparatı | 1          | 4,60 \$  |

**5W Dış Mekan Spotu**  
GU10 Duylu Lamba Dahil

Alüminyum  
Enjeksiyon



IP 65

| Kod No | Özellikler             | Koli Adedi | Fiyat    |
|--------|------------------------|------------|----------|
| 109425 | 5W 6500K (Kazık Dahil) | 20         | 16,10 \$ |

**LEDli Yer Gömme 20**  
15 LED'li



IP65

| Kod No | Özellikler    | Koli Adedi | Fiyat    |
|--------|---------------|------------|----------|
| 204283 | 15W 4000K Ø20 | 8          | 75,10 \$ |

**LEDli Yer Gömme 15**  
9 LED'li

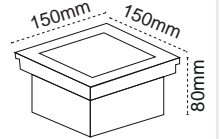

IP65

| Kod No | Özellikler   | Koli Adedi | Fiyat    |
|--------|--------------|------------|----------|
| 204282 | 9W 4000K Ø15 | 12         | 44,10 \$ |

**Duvar Gömme Armatürü**  
Pialed

Alüminyum  
Enjeksiyon

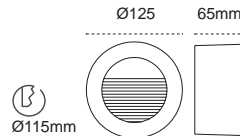
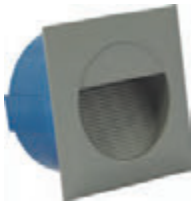

IP54

| Kod No | Özellikler     | Koli Adedi | Fiyat    |
|--------|----------------|------------|----------|
| 204441 | 14 LEDli 4000K | 24         | 15,90 \$ |

**Duvar Gömme Armatürü**  
Dialed

Alüminyum  
Enjeksiyon

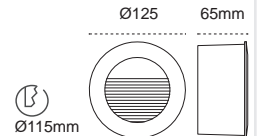
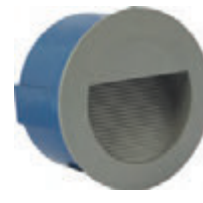

IP54

| Kod No | Özellikler     | Koli Adedi | Fiyat    |
|--------|----------------|------------|----------|
| 204442 | 14 LEDli 4000K | 24         | 15,90 \$ |



## Ömrü Boyunca Aynı Işık Çıktısı

- 30.000 saat ömür
- 3M Bant
- Her 3 modülde bir kesilebilme
- 12V DC ile çalışır



| Sürücü Seçim Tablosu |           |
|----------------------|-----------|
| Sürücü               | LED Şerit |
| 2,5 A                | max 2,5m  |
| 5 A                  | max 5m    |
| 8 A                  | max 8m    |
| 12,5 A               | max 12m   |
| 17 A                 | max 15m   |
| 21 A                 | max 18m   |
| 30 A                 | max 30m   |

### İç Mekan LED Şerit Üç Çip IP20

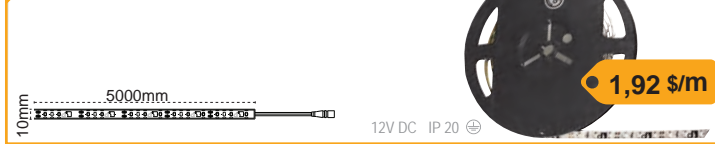

| Kod No | Özellikler                   | Koli Adedi | Fiyat    |
|--------|------------------------------|------------|----------|
| 204962 | IP20 SMD LED 3000K 5 metre   | 100        | 9,60 \$  |
| 203688 | IP20 SMD LED 4000K 5 metre   | 100        | 9,60 \$  |
| 203687 | IP20 SMD LED 6500K 5 metre   | 100        | 9,60 \$  |
| 203692 | IP20 SMD LED Sarı 5 metre    | 100        | 9,60 \$  |
| 203689 | IP20 SMD LED Kırmızı 5 metre | 100        | 9,60 \$  |
| 203693 | IP20 SMD LED Yeşil 5 metre   | 100        | 9,60 \$  |
| 203690 | IP20 SMD LED Mavi 5 metre    | 100        | 9,60 \$  |
| 203691 | IP20 SMD LED RGB 5 metre     | 100        | 22,20 \$ |

### 12V IP20 Sabit Gerilim Sürücüler



| Kod No | Özellikler     | Koli Adedi | Fiyat    |
|--------|----------------|------------|----------|
| 313240 | 60W 12V 5A     | 120        | 9,30 \$  |
| 313242 | 100W 12V 8,5A  | 80         | 12,50 \$ |
| 313244 | 150W 12V 12,5A | 60         | 15,70 \$ |
| 313246 | 200W 12V 16,5A | 36         | 19,30 \$ |
| 313252 | 250W 12V 21A   | 36         | 23,00 \$ |
| 313248 | 360W 12V 30A   | 36         | 24,00 \$ |

### Dış Mekan LED Şerit Üç Çip IP55



| Kod No | Özellikler                   | Koli Adedi | Fiyat    |
|--------|------------------------------|------------|----------|
| 203695 | IP55 SMD LED 4000K 5 metre   | 50         | 13,00 \$ |
| 203694 | IP55 SMD LED 6500K 5 metre   | 50         | 13,00 \$ |
| 203699 | IP55 SMD LED Sarı 5 metre    | 50         | 13,00 \$ |
| 203696 | IP55 SMD LED Kırmızı 5 metre | 50         | 13,00 \$ |
| 203700 | IP55 SMD LED Yeşil 5 metre   | 50         | 13,00 \$ |
| 203697 | IP55 SMD LED Mavi 5 metre    | 50         | 13,00 \$ |
| 203698 | IP55 SMD LED RGB 5 metre     | 50         | 25,40 \$ |

### 12V IP67 Sabit Gerilim Sürücüler



| Kod No | Özellikler    | Koli Adedi | Fiyat    |
|--------|---------------|------------|----------|
| 313249 | 60W 12V 5A    | 70         | 16,90 \$ |
| 313250 | 100W 12V 8,5A | 32         | 33,80 \$ |

### 24V LED Şerit IP20 Üç Çip



| Kod No | Özellikler                | Koli Adedi | Fiyat    |
|--------|---------------------------|------------|----------|
| 204801 | 24W SMD LED Beyaz 5 metre | 100        | 10,20 \$ |

### 24V IP20 Sabit Gerilim Sürücüler



| Kod No | Özellikler     | Koli Adedi | Fiyat    |
|--------|----------------|------------|----------|
| 314833 | 60W 24V 2,5A   | 120        | 9,10 \$  |
| 314834 | 120W 24V 5A    | 80         | 13,60 \$ |
| 314835 | 200W 24V 7,25A | 36         | 19,20 \$ |
| 314836 | 360W 24V 15A   | 36         | 20,30 \$ |

## Neon LED



### Ultra Esnek!

Pelsan Neon LED özel silikonu ve flexible PCB'si sayesinde **ultra esnekliğe** sahiptir.



### Ultra Parlak!

Özel silikon yapısı ışığın homojenize olmasını sağlarken **ultra parlaklık sunar.**



### Toz ve Su Almaz!

IP65 koruma sınıfı ile dış mekanda kullanılır.



### Kullanım Kolaylığı!

Metrede bir kesilebilir.



220-240V AC ile çalışır. Kullanımı kolaydır. 50 metreye kadar kesintisiz kullanılır.

Ultra Esnek! Ultra Parlak!



## Neon LED 50 m



### Aparatlar fiyata dahildir.

- Fişli Kablo (1 Adet)
- Birleştirme Aparatı (1 Adet)
- Sonlandırma Aparatı (1 Adet)

IP 65

| Kod No | Özellikler           | Koli Adedi | Fiyat     |
|--------|----------------------|------------|-----------|
| 203717 | Neon LED 5500K 50m   | 1          | 314,10 \$ |
| 203722 | Neon LED Amber 50m   | 1          | 314,10 \$ |
| 203719 | Neon LED Kırmızı 50m | 1          | 314,10 \$ |
| 203720 | Neon LED Mavi 50m    | 1          | 314,10 \$ |
| 203723 | Neon LED Yeşil 50m   | 1          | 314,10 \$ |
| 203721 | Neon LED RGB 50m     | 1          | 535,10 \$ |

## Neon LED 25 m



### Aparatlar fiyata dahildir.

- Fişli Kablo (1 Adet)
- Birleştirme Aparatı (1 Adet)
- Sonlandırma Aparatı (1 Adet)

IP 65

| Kod No | Özellikler         | Koli Adedi | Fiyat     |
|--------|--------------------|------------|-----------|
| 205251 | Neon LED 3000K 25m | 1          | 157,10 \$ |
| 205258 | Neon LED 5500K 25m | 1          | 157,10 \$ |

## Neon Aksesuarlar

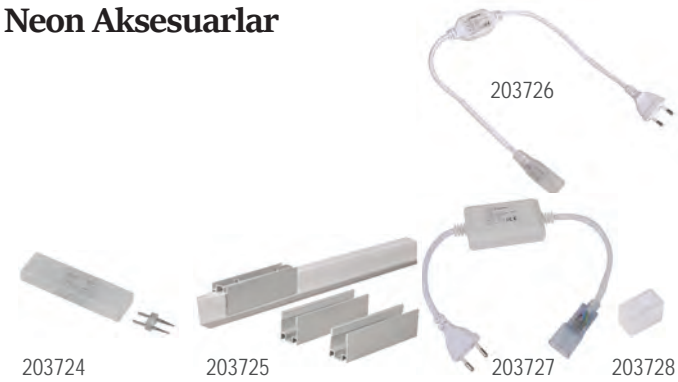

| Kod No | Özellikler                                      | Koli Adedi | Fiyat    |
|--------|---|------------|----------|
| 203726 | Neon LED Bağlantı Aparatı (Fişli Kablolulu)     | 1          | 8,60 \$  |
| 203727 | Neon LED RGB Bağlantı Aparatı (RGB Fişli Kablo) | 1          | 9,70 \$  |
| 203725 | Neon LED Alüminyum Montaj Aparatı (5 cm)        | (10'lu)    | 11,30 \$ |
| 203724 | Neon LED Birleştirme Aparatı                    | (10'lu)    | 7,90 \$  |
| 203728 | Neon LED Sonlandırma Aparatı                    | (10'lu)    | 4,60 \$  |
| 204839 | Neon LED RGB Birleştirme Aparatı                | (10'lu)    | 18,10 \$ |

## 3'lü Zincir Modül



IP 65

| Kod No | Özellikler                       | Koli Adedi | Fiyat    |
|--------|----------------------------------|------------|----------|
| 203731 | 1,2W/ad. 12V Ilık Beyaz100 Modül | 2000       | 44,10 \$ |
| 203733 | 1,2W/ad. 12V Kırmızı100 Modül    | 2000       | 64,10 \$ |
| 203734 | 1,2W/ad. 12V Sarı100 Modül       | 2000       | 64,10 \$ |
| 203732 | 1,2W/ad. 12V Amber100 Modül      | 2000       | 64,10 \$ |
| 203729 | 0,72W/ad. 12V RGB100 Modül       | 2000       | 75,10 \$ |

## LED Glop Lambalar



5W

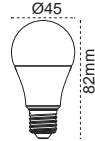

7W

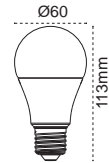

9W

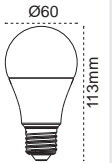

| Kod No | Özellikler       | Koli Adedi | Fiyat   | Kod No | Özellikler       | Koli Adedi | Fiyat   | Kod No | Özellikler       | Koli Adedi | Fiyat   |
|--------|------------------|------------|---------|--------|------------------|------------|---------|--------|------------------|------------|---------|
| 315105 | 5W 2700K E27 Ø45 | 100        | 1,70 \$ | 313406 | 7W 2700K E27 Ø60 | 100        | 1,92 \$ | 313411 | 9W 2700K E27 Ø60 | 100        | 1,92 \$ |
| 315106 | 5W 6400K E27 Ø45 | 100        | 1,70 \$ | 313407 | 7W 6400K E27 Ø60 | 100        | 1,92 \$ | 313415 | 9W 6400K E27 Ø60 | 100        | 1,92 \$ |

## Yüksek Güçlü Lambalar



18W

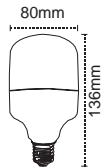

28W

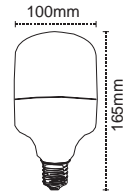

38W

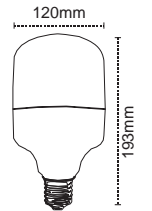

| Kod No | Özellikler    | Koli Adedi | Fiyat   | Kod No | Özellikler    | Koli Adedi | Fiyat   | Kod No | Özellikler    | Koli Adedi | Fiyat    |
|--------|---------------|------------|---------|--------|---------------|------------|---------|--------|---------------|------------|----------|
| 317863 | 18W 6500K E27 | 30         | 5,90 \$ | 313420 | 28W 6500K E27 | 20         | 8,35 \$ | 313421 | 38W 6500K E27 | 20         | 11,10 \$ |

## Spot / Buji / Acil LED Lambalar



313388



315173

**Power LED Lamba**

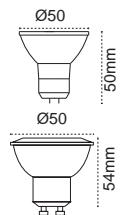

313395 313396

**Buji LED Lamba**

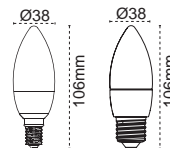

**Şarj Edilebilir LED Lamba**

**3 saat**  
Acil Durum Aydınlatma

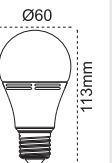

| Kod No | Özellikler       | Koli Adedi | Fiyat   | Kod No | Özellikler       | Koli Adedi | Fiyat   | Kod No | Özellikler   | Koli Adedi | Fiyat   |
|--------|------------------|------------|---------|--------|------------------|------------|---------|--------|--------------|------------|---------|
| 313388 | 3x1W 2700K GU5.5 | 100        | 1,70 \$ | 313395 | 4W 2700K E14 Ø60 | 100        | 1,70 \$ | 315107 | 9W 6500K E27 | 50         | 7,00 \$ |
| 315173 | 5W 6400K GU10    | 100        | 1,75 \$ | 313396 | 4W 6500K E27 Ø60 | 100        | 1,70 \$ |        |              |            |         |

**Filament Lamba  
(T20)**

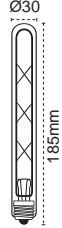

| Kod No | Özellikler       | Koli Adedi | Fiyat   |
|--------|------------------|------------|---------|
| 318053 | 6W 2700K E27 T20 | 20         | 6,60 \$ |

**Filament Lamba  
(Ø64)**

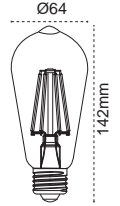

| Kod No | Özellikler            | Koli Adedi | Fiyat   |
|--------|-----------------------|------------|---------|
| 314440 | 6W Filament E27 2700K | 40         | 4,85 \$ |

**Filament Lamba  
(Ø95)**

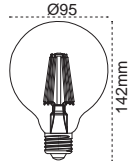

| Kod No | Özellikler            | Koli Adedi | Fiyat   |
|--------|-----------------------|------------|---------|
| 313441 | 6W Filament E27 2700K | 20         | 6,65 \$ |

**Filament Lamba  
(Ø125)**

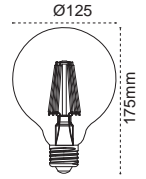

| Kod No | Özellikler            | Koli Adedi | Fiyat   |
|--------|-----------------------|------------|---------|
| 313442 | 6W Filament E27 2700K | 20         | 7,60 \$ |

**Filament Lamba  
(Ø60)**

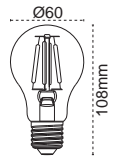

| Kod No | Özellikler                  | Koli Adedi | Fiyat   |
|--------|-----------------------------|------------|---------|
| 313438 | 4W Filament Lamba E27 3000K | 100        | 3,00 \$ |
| 313444 | 4W Filament Lamba E27 6500K | 100        | 3,00 \$ |

**Buji Filament Lamba**

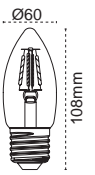

| Kod No | Özellikler              | Koli Adedi | Fiyat   |
|--------|-------------------------|------------|---------|
| 313437 | 4W Buji Lamba E27 3000K | 100        | 3,00 \$ |
| 313439 | 4W Buji Lamba E27 6500K | 100        | 3,00 \$ |

**LED Tube**  
Cam Gövde



  
Tek Taraftan  
Bağlantı

 Enerji Tasarrufu

 Kolay Kurulum

 60 / 120 / 150 cm Boy Seçeeği

| Kod No | Özellikler |       |       | Koli Adedi | Fiyat   | Kod No | Özellikler |       |       | Koli Adedi | Fiyat    |
|--------|------------|-------|-------|------------|---------|--------|------------|-------|-------|------------|----------|
| 314663 | 9W         | 4000K | 60cm  | 25         | 4,20 \$ | 314669 | 22W        | 4000K | 150cm | 25         | 11,85 \$ |
| 314664 | 9W         | 6500K | 60cm  | 25         | 4,20 \$ | 314671 | 22W        | 6500K | 150cm | 25         | 13,70 \$ |
| 314666 | 18W        | 4000K | 120cm | 25         | 5,54 \$ |        |            |       |       |            |          |
| 314665 | 18W        | 6500K | 120cm | 25         | 5,54 \$ |        |            |       |       |            |          |

**Koridor Fonksiyonlu**  
ABS Gövde LED Tube



  
Çift Taraftan  
Bağlantı



**Çalışma Şekli**

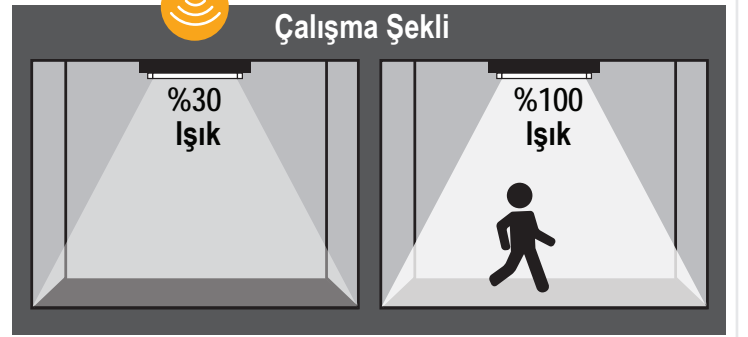

| Kod No | Özellikler |       |       | Koli Adedi | Fiyat    |
|--------|------------|-------|-------|------------|----------|
| 315115 | 18W Sensör | 6500K | 120cm | 25         | 16,65 \$ |

**LED Tube Işıldak (1,5 saat)**  
Cam Gövde LED Tube



  
Çift Taraftan  
Bağlantı



**Çalışma Şekli**

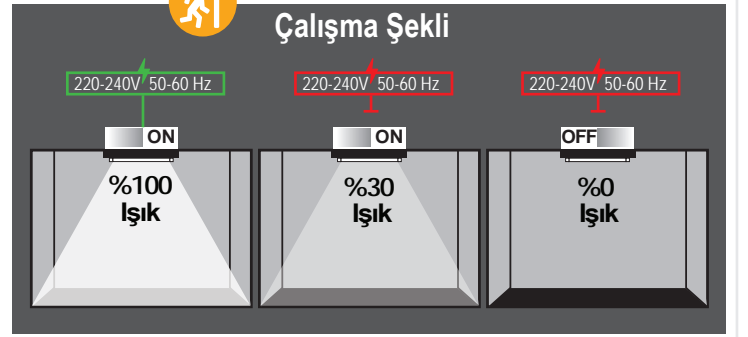

| Kod No | Özellikler |       |       | Koli Adedi | Fiyat    |
|--------|------------|-------|-------|------------|----------|
| 315116 | 18W Acil   | 6500K | 120cm | 25         | 17,50 \$ |

**Bitki Yetiştirici**  
LED Tube



  
Tek Taraftan  
Bağlantı



Bitki Yetiştirmek için En Uygun Dalga Boyu  
610-650



Filizler, Büyütür, Olgunlaştırır



Kolay Kurulum

| Kod No | Özellikler        |  |  | Koli Adedi | Fiyat    |
|--------|-------------------|--|--|------------|----------|
| 315113 | 18W Full Spectrum |  |  | 25         | 13,40 \$ |

### Sodyum Lambalar



|      | axbmm  |
|------|--------|
| 50W  | 160x38 |
| 70W  | 160x38 |
| 100W | 204x46 |
| 150W | 204x46 |
| 250W | 270x46 |
| 400W | 360x66 |

| Kod No | Özellikler      | Koli Adedi | Fiyat    |
|--------|-----------------|------------|----------|
| 313504 | 50W 2000K E27   | 25         | 7,50 \$  |
| 313506 | 100W 2000K E40  | 24         | 8,70 \$  |
| 313510 | 1000W 2000K E40 | 20         | 45,00 \$ |

### Metal Lambalar



|       | axbmm  |
|-------|--------|
| 150W  | 204x46 |
| 250W  | 247x46 |
| 400W  | 267x46 |
| 1000W | 367x66 |

| Kod No | Özellikler      | Koli Adedi | Fiyat    |
|--------|-----------------|------------|----------|
| 313514 | 400W 5500K E40  | 24         | 13,10 \$ |
| 313512 | 1000W 5500K E40 | 20         | 45,00 \$ |

### Metal Lambalar G12



|          | axbmm   |
|----------|---------|
| 70W G12  | 89x22,5 |
| 150W G12 | 99x22,5 |

| Kod No | Özellikler     | Koli Adedi | Fiyat    |
|--------|----------------|------------|----------|
| 313519 | 70W 5500K G12  | 100        | 9,70 \$  |
| 313521 | 70W 3000K G12  | 100        | 9,70 \$  |
| 313522 | 150W 3000K G12 | 100        | 10,70 \$ |

### Par Lamba

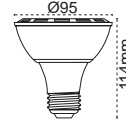

| Kod No | Özellikler                  | Koli Adedi | Fiyat    |
|--------|-----------------------------|------------|----------|
| 313408 | 12X1W PAR38 Lamba 4000K E27 | 20         | 10,40 \$ |
| 313409 | 12X1W PAR38 Lamba 6500K E27 | 20         | 10,40 \$ |

### Kapsül Lamba G4



| Kod No | Özellikler             | Koli Adedi | Fiyat   |
|--------|------------------------|------------|---------|
| 313459 | 3W Kapsül 3000K G4 12V | 100        | 2,00 \$ |

### GU 5,3 Duylu Lamba

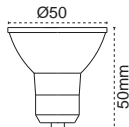

| Kod No | Özellikler       | Koli Adedi | Fiyat   |
|--------|------------------|------------|---------|
| 313388 | 3X1W 3000K GU5,3 | 200        | 1,70 \$ |

### GU10 Duylu Lamba

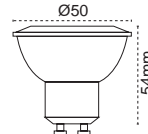

| Kod No | Özellikler    | Koli Adedi | Fiyat   |
|--------|---------------|------------|---------|
| 315173 | 5W 6500K GU10 | 100        | 1,75 \$ |

### Kapsül Lamba G4-G9



| Kod No | Özellikler              | Koli Adedi | Fiyat   |
|--------|-------------------------|------------|---------|
| 313460 | 3W Kapsül 3000K G9 220V | 100        | 2,00 \$ |
| 313461 | 3W Kapsül 3000K G4 220V | 100        | 2,00 \$ |

### Y.B Metal Halide

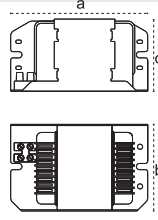

IP 40

| Kod No | Özellikler                | axbxcmm     | Koli Adedi | Fiyat     |
|--------|---------------------------|-------------|------------|-----------|
| 313048 | Metal Halide 35W          | 155x42x33   | 24         | 9,98 \$   |
| 313051 | Metal Halide 70W          | 116x64x54   | 16         | 10,92 \$  |
| 313052 | Metal Halide 150W         | 122x78x66   | 8          | 16,17 \$  |
| 313053 | Metal Halide 250W         | 135x93x79   | 4          | 25,10 \$  |
| 313055 | Metal Halide 400W         | 135x93x79   | 4          | 25,99 \$  |
| 313057 | Metal Halide 1000W        | 197x126x138 | 2          | 77,60 \$  |
| 313059 | Metal Halide 2000W (380V) | 225x126x138 | 1          | 111,93 \$ |

### Y.B Sodyum Buharlı

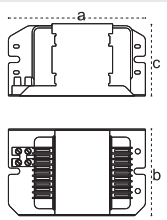

IP 40

| Kod No | Özellikler           | axbxcmm     | Koli Adedi | Fiyat    |
|--------|----------------------|-------------|------------|----------|
| 313037 | Sodyum Buharlı 50W   | 116x64x54   | 16         | 10,66 \$ |
| 313040 | Sodyum Buharlı 70W   | 116x64x54   | 16         | 11,03 \$ |
| 313038 | Sodyum Buharlı 100W  | 116x64x54   | 16         | 11,24 \$ |
| 313041 | Sodyum Buharlı 150W  | 122x78x66   | 4          | 16,28 \$ |
| 313042 | Sodyum Buharlı 250W  | 135x93x72   | 4          | 24,78 \$ |
| 313043 | Sodyum Buharlı 400W  | 156x93x69   | 2          | 29,61 \$ |
| 313047 | Sodyum Buharlı 600W  | 178x126x138 | 2          | 56,07 \$ |
| 313045 | Sodyum Buharlı 1000W | 197x126x138 | 2          | 71,72 \$ |

### Metal Kitler

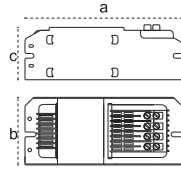

IP 20

| Kod No | Özellikler                      | axbxcmm     | Koli Adedi | Fiyat     |
|--------|---------------------------------|-------------|------------|-----------|
| 200078 | Metal Kit 35W Balast + ignitör  | 185x115x88  | 4          | 21,21 \$  |
| 200069 | Metal Kit 70W Balast + ignitör  | 150x64x54   | 4          | 22,47 \$  |
| 200070 | Metal Kit 150W Balast + ignitör | 166x77x65   | 4          | 32,66 \$  |
| 200074 | Metal Kit 250W Balast + ignitör | 205x93x79   | 4          | 42,00 \$  |
| 200076 | Metal Kit 400W Balast + ignitör | 232x93x79   | 4          | 44,73 \$  |
| 105227 | Olimpiad Kiti 1000W             | 246x126x138 | 1          | 113,40 \$ |

### Sera Kitler

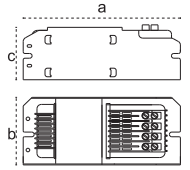

IP 20

| Kod No | Özellikler               | axbxcmm     | Koli Adedi | Fiyat    |
|--------|--------------------------|-------------|------------|----------|
| 200066 | Sera 400W SB Balast Kiti | 232x93x79   | 4          | 57,02 \$ |
| 200067 | Sera 600W SB Balast Kiti | 246x126x138 | 1          | 97,97 \$ |

### Silver Floresant Balast

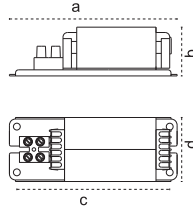

IP 40

| Kod No | Özellikler | axbxcxdmm      | Koli Adedi | Fiyat   |
|--------|------------|----------------|------------|---------|
| 312959 | 15W TLD    | 100x32,2x87x42 | 36         | 3,78 \$ |
| 312969 | 20W TLD    | 100x32,2x87x42 | 36         | 3,78 \$ |
| 312975 | 32W TLD    | 100x32,2x87x42 | 36         | 3,78 \$ |
| 312971 | 36-40W TLD | 100x32,2x87x42 | 36         | 3,78 \$ |

### Elektronik Balast

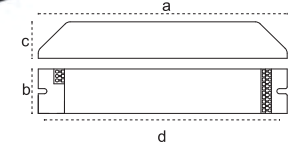

IP 40

| Kod No | Özellikler | axbxcxdmm     | Koli Adedi | Fiyat    |
|--------|------------|---------------|------------|----------|
| 313142 | 1X18W TLD  | 295x31x29x285 | 10         | 10,50 \$ |
| 313144 | 2X18W TLD  | 295x31x29x285 | 10         | 10,50 \$ |
| 313143 | 1X36W TLD  | 295x31x29x285 | 10         | 10,50 \$ |
| 313145 | 2X36W TLD  | 295x31x29x285 | 10         | 10,50 \$ |
| 313158 | 4X14W T5   | 332x34x32x322 | 10         | 10,50 \$ |

### İgnitör

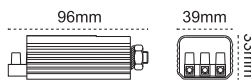

IP 20

| Kod No | Özellikler             | Koli Adedi | Fiyat    |
|--------|------------------------|------------|----------|
| 303902 | Zaman Ayarlı 50-400W   | 10         | 9,87 \$  |
| 303880 | İgnitör 70-400W        | 10         | 7,25 \$  |
| 303906 | 600-1000W (25 m kadar) | 10         | 16,80 \$ |
| 303900 | İgnitör 600-1000W      | 10         | 16,80 \$ |

### Starter

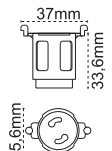

IP 20

| Kod No | Özellikler | Koli Adedi | Fiyat   |
|--------|------------|------------|---------|
| 303850 | 4-65W      | 25         | 0,32 \$ |
| 303851 | Seri 4-22W | 25         | 0,32 \$ |

### LED Konvertör Kit (1 Saat)



IP 20

| Kod No | Özellikler                         | Koli Adedi | Fiyat    |
|--------|------------------------------------|------------|----------|
| 313118 | 12-110V LED Konvertör Kit (1 Saat) | 50         | 26,00 \$ |

### LED Konvertör Kit (3 Saat)



IP 20

| Kod No | Özellikler                         | Koli Adedi | Fiyat    |
|--------|------------------------------------|------------|----------|
| 316611 | 12-110V LED Konvertör Kit (3 Saat) | 50         | 30,30 \$ |

### LED Tube Konvertör Kit



IP 20

| Kod No | Özellikler                   | Koli Adedi | Fiyat    |
|--------|------------------------------|------------|----------|
| 313117 | 9-18W LED Tube Konvertör Kit | 25         | 26,00 \$ |

### IP20 Sabit Akım LED Sürücüler

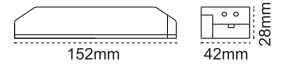

IP 20

| Kod No | Özellikler                           | Koli Adedi | Fiyat    |
|--------|--------------------------------------|------------|----------|
| 313180 | 20W 600 mA 16-42 V DC Çıkış Gerilimi | 100        | 13,50 \$ |
| 313181 | 15W 700 mA 11-25 V DC Çıkış Gerilimi | 100        | 13,50 \$ |
| 313179 | 25W 400 mA 25-63 V DC Çıkış Gerilimi | 100        | 16,88 \$ |
| 313170 | 40W 600 mA 33-68 V DC Çıkış Gerilimi | 100        | 16,88 \$ |

### Floresan Konvertör Kit (1 Saat)

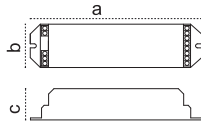

IP 20

| Kod No | Özellikler                           | axbxcmm   | Koli Adedi | Fiyat    |
|--------|--------------------------------------|-----------|------------|----------|
| 313089 | 18-36W Mekanik Balast için 1 Saat    | 170x43x31 | 10         | 39,38 \$ |
| 313122 | 18-36W Elektronik Balast için 1 Saat | 170x43x31 | 10         | 45,00 \$ |

### Floresan Konvertör Kit (3 Saat)

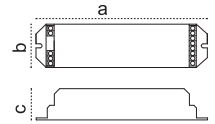

IP 20

| Kod No | Özellikler                           | axbxcmm   | Koli Adedi | Fiyat    |
|--------|--------------------------------------|-----------|------------|----------|
| 313092 | 18-36W Mekanik Balast için 3 Saat    | 170x43x31 | 10         | 39,38 \$ |
| 313123 | 18-36W Elektronik Balast için 3 Saat | 170x43x31 | 10         | 45,00 \$ |

### Tij Takımı



IP 20

| Kod No | Özellikler              | Koli Adedi | Fiyat   |
|--------|-------------------------|------------|---------|
| 304026 | Porselen Tij Takımı E27 | 50         | 0,79 \$ |

### Acil Aydınlatma Spotu (3 Saat)

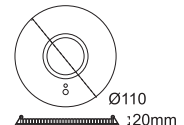

IP 20

| Kod No | Özellikler      | Koli Adedi | Fiyat    |
|--------|-----------------|------------|----------|
| 204465 | 3W 6500K (2'li) | 20         | 33,80 \$ |



## Çeşme

### Grup Priz Serisi



| Kod No | Cinsi                   | Koli Ad. | Çeşme Seri |
|--------|-------------------------|----------|------------|
| 203790 | Çesme 2'li Klemensli    | 100      | 1,75 \$    |
| 203787 | Çesme 2'li 2 mt Kablolu | 48       | 3,91 \$    |
| 203788 | Çesme 2'li 3 mt Kablolu | 48       | 7,00 \$    |
| 203789 | Çesme 2'li 5 mt Kablolu | 24       | 12,02 \$   |
| 203794 | Çesme 3'lü Klemensli    | 100      | 1,98 \$    |
| 203791 | Çesme 3'lü 2 mt Kablolu | 48       | 4,08 \$    |
| 203792 | Çesme 3'lü 3 mt Kablolu | 48       | 7,23 \$    |
| 203793 | Çesme 3'lü 5 mt Kablolu | 24       | 12,19 \$   |
| 203798 | Çesme 4'lü Klemensli    | 100      | 2,45 \$    |
| 203795 | Çesme 4'lü 2 mt Kablolu | 36       | 4,61 \$    |
| 203796 | Çesme 4'lü 3 mt Kablolu | 36       | 7,70 \$    |
| 203797 | Çesme 4'lü 5 mt Kablolu | 24       | 12,72 \$   |
| 203802 | Çesme 5'li Klemensli    | 100      | 2,98 \$    |
| 203799 | Çesme 5'li 2 mt Kablolu | 36       | 5,13 \$    |
| 203800 | Çesme 5'li 3 mt Kablolu | 36       | 8,23 \$    |
| 203801 | Çesme 5'li 5 mt Kablolu | 24       | 13,24 \$   |
| 203806 | Çesme 6'li Klemensli    | 100      | 3,44 \$    |
| 203803 | Çesme 6'li 2 mt Kablolu | 48       | 5,60 \$    |
| 203804 | Çesme 6'li 3 mt Kablolu | 48       | 8,69 \$    |
| 203805 | Çesme 6'li 5 mt Kablolu | 24       | 13,71 \$   |

#### UPS Çeşme Anahtarlı

|        |                       |     |          |
|--------|-----------------------|-----|----------|
| 204136 | Ups 3'lü Klemensli    | 100 | 2,10 \$  |
| 204133 | Ups 3'lü 2 mt Kablolu | 36  | 4,26 \$  |
| 204134 | Ups 3'lü 3 mt Kablolu | 36  | 7,35 \$  |
| 204135 | Ups 3'lü 5 mt Kablolu | 24  | 12,37 \$ |
| 204140 | Ups 4'lü Klemensli    | 100 | 2,92 \$  |
| 204137 | Ups 4'lü 2 mt Kablolu | 36  | 5,08 \$  |
| 204138 | Ups 4'lü 3 mt Kablolu | 36  | 8,17 \$  |
| 204139 | Ups 4'lü 5 mt Kablolu | 24  | 13,18 \$ |
| 204144 | Ups 6'li Klemensli    | 100 | 4,14 \$  |
| 204141 | Ups 6'li 2 mt Kablolu | 36  | 6,30 \$  |
| 204142 | Ups 6'li 3 mt Kablolu | 36  | 9,39 \$  |
| 204143 | Ups 6'li 5 mt Kablolu | 24  | 14,41 \$ |

## Foça

### Anahtarlı Grup Priz Serisi



| Kod No | Cinsi                       | Koli Ad. | Foça Seri |
|--------|-----------------------------|----------|-----------|
| 204353 | Anahtarlı 2'li Klemensli    | 100      | 2,63 \$   |
| 204350 | Anahtarlı 2'li 2 mt Kablolu | 48       | 4,78 \$   |
| 204351 | Anahtarlı 2'li 3 mt Kablolu | 48       | 7,88 \$   |
| 204352 | Anahtarlı 2'li 5 mt Kablolu | 24       | 12,83 \$  |
| 204357 | Anahtarlı 3'lü Klemensli    | 100      | 2,86 \$   |
| 204354 | Anahtarlı 3'lü 2 mt Kablolu | 48       | 4,96 \$   |
| 204355 | Anahtarlı 3'lü 3 mt Kablolu | 48       | 8,05 \$   |
| 204356 | Anahtarlı 3'lü 5 mt Kablolu | 24       | 13,07 \$  |
| 204361 | Anahtarlı 4'lü Klemensli    | 100      | 3,33 \$   |
| 204358 | Anahtarlı 4'lü 2 mt Kablolu | 36       | 5,48 \$   |
| 204359 | Anahtarlı 4'lü 3 mt Kablolu | 36       | 8,58 \$   |
| 204360 | Anahtarlı 4'lü 5 mt Kablolu | 24       | 13,59 \$  |
| 204365 | Anahtarlı 5'li Klemensli    | 100      | 3,85 \$   |
| 204362 | Anahtarlı 5'li 2 mt Kablolu | 36       | 6,01 \$   |
| 204363 | Anahtarlı 5'li 3 mt Kablolu | 36       | 9,10 \$   |
| 204364 | Anahtarlı 5'li 5 mt Kablolu | 24       | 14,12 \$  |
| 204369 | Anahtarlı 6'li Klemensli    | 100      | 4,32 \$   |
| 204366 | Anahtarlı 6'li 2 mt Kablolu | 36       | 6,48 \$   |
| 204367 | Anahtarlı 6'li 3 mt Kablolu | 36       | 9,57 \$   |
| 204368 | Anahtarlı 6'li 5 mt Kablolu | 24       | 14,58 \$  |

#### UPS Foça Anahtarlı

|        |                        |     |          |
|--------|------------------------|-----|----------|
| 204373 | 5'li Klemensli Priz    | 100 | 4,43 \$  |
| 204370 | 5'li 2 mt Kablolu Priz | 36  | 6,59 \$  |
| 204371 | 5'li 3 mt Kablolu Priz | 36  | 9,68 \$  |
| 204372 | 5'li 5 mt Kablolu Priz | 24  | 14,70 \$ |

Belek Çocuk Korumalı  
Eviniz de Cebiniz de **GÜVENDE!**

**5 Yıl Garanti**



Çocuk Korumalı



Alev Almaz Gövde  
(850°C Isıya Dayanıklı)



Halojen Free Malzeme



Anahtarlı / Anahtarsız  
Opsiyonu



Duvara Askı

### 3'lü

Çocuk Korumalı



| Kod No | Cinsi                         | Koli Ad. | Fiyat           |
|--------|-------------------------------|----------|-----------------|
| 204975 | 3'lü Klemensli (5951 4030)    | 100      | <b>2,10 \$</b>  |
| 204922 | 3'lü 2 mt Kablolu (5951 4032) | 48       | <b>4,26 \$</b>  |
| 204923 | 3'lü 3 mt Kablolu (5951 4033) | 48       | <b>7,35 \$</b>  |
| 204924 | 3'lü 5 mt Kablolu (5951 4035) | 24       | <b>12,31 \$</b> |

### 3'lü Anahtarlı

Çocuk Korumalı



| Kod No | Cinsi                         | Koli Ad. | Fiyat           |
|--------|-------------------------------|----------|-----------------|
| 204977 | 3'lü Klemensli (5951 4130)    | 100      | <b>2,98 \$</b>  |
| 204925 | 3'lü 2 mt Kablolu (5951 4132) | 48       | <b>5,13 \$</b>  |
| 204926 | 3'lü 3 mt Kablolu (5951 4133) | 48       | <b>8,23 \$</b>  |
| 204927 | 3'lü 5 mt Kablolu (5951 4135) | 24       | <b>13,18 \$</b> |

### 4'lü

Çocuk Korumalı



| Kod No | Cinsi                         | Koli Ad. | Fiyat           |
|--------|-------------------------------|----------|-----------------|
| 204978 | 4'lü Klemensli (5951 4040)    | 100      | <b>2,63 \$</b>  |
| 204929 | 4'lü 2 mt Kablolu (5951 4042) | 36       | <b>4,73 \$</b>  |
| 204930 | 4'lü 3 mt Kablolu (5951 4043) | 36       | <b>7,82 \$</b>  |
| 204931 | 4'lü 5 mt Kablolu (5951 4045) | 24       | <b>12,83 \$</b> |

### 4'lü Anahtarlı

Çocuk Korumalı



| Kod No | Cinsi                         | Koli Ad. | Fiyat           |
|--------|-------------------------------|----------|-----------------|
| 204979 | 4'lü Klemensli (5951 4140)    | 100      | <b>3,50 \$</b>  |
| 204932 | 4'lü 2 mt Kablolu (5951 4142) | 36       | <b>5,60 \$</b>  |
| 204933 | 4'lü 3 mt Kablolu (5951 4143) | 36       | <b>8,69 \$</b>  |
| 204934 | 4'lü 5 mt Kablolu (5951 4145) | 24       | <b>13,71 \$</b> |

### 6'lı

Çocuk Korumalı



| Kod No | Cinsi                         | Koli Ad. | Fiyat           |
|--------|-------------------------------|----------|-----------------|
| 204980 | 6'lı Klemensli (5951 4060)    | 100      | <b>3,56 \$</b>  |
| 204935 | 6'lı 2 mt Kablolu (5951 4062) | 36       | <b>5,60 \$</b>  |
| 204936 | 6'lı 3 mt Kablolu (5951 4063) | 36       | <b>8,81 \$</b>  |
| 204937 | 6'lı 5 mt Kablolu (5951 4065) | 24       | <b>13,83 \$</b> |

### 6'lı Anahtarlı

Çocuk Korumalı



| Kod No | Cinsi                         | Koli Ad. | Fiyat           |
|--------|-------------------------------|----------|-----------------|
| 204981 | 6'lı Klemensli (5951 4160)    | 100      | <b>4,43 \$</b>  |
| 204938 | 6'lı 2 mt Kablolu (5951 4162) | 36       | <b>6,48 \$</b>  |
| 204939 | 6'lı 3 mt Kablolu (5951 4163) | 36       | <b>9,68 \$</b>  |
| 204940 | 6'lı 5 mt Kablolu (5951 4165) | 24       | <b>14,70 \$</b> |



## Belek USB Grup Priz



## USB Anahtarlı

## Çocuk Korumalı



| Kod No | Cinsi                             | Koli Ad. | Fiyat    |
|--------|-----------------------------------|----------|----------|
| 204985 | Usb 3'lü 2 mt Kablolu (5951 4232) | 36       | 18,08 \$ |
| 204986 | Usb 3'lü 3 mt Kablolu (5951 4233) | 36       | 19,02 \$ |
| 204987 | Usb 3'lü 5 mt Kablolu (5951 4235) | 24       | 20,94 \$ |

## Aksesuarlar

| Kod No | Cinsi                     | Koli Ad. | Aksesuar Serisi |
|--------|---------------------------|----------|-----------------|
| 204402 | Topraksız Erkek Fiş       | 1000     | 0,54 \$         |
| 204401 | Topraklı Erkek Fiş        | 500      | 0,71 \$         |
| 204400 | Topraklı Dişi Fiş         | 250      | 0,76 \$         |
| 204399 | Toprak Erkek L Modeli Fiş | 500      | 0,71 \$         |

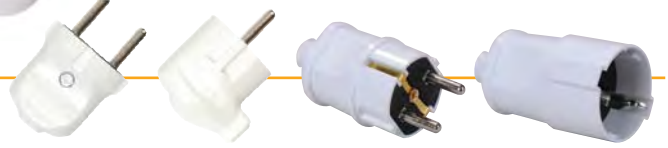

## Fişler

| Kod No | Cinsi         | Koli Ad. | Fiş Prizler Serisi |
|--------|---------------|----------|--------------------|
| 204395 | Fiş Priz 3'lü | 100      | 2,39 \$            |
| 204396 | Fiş Priz 4'lü | 100      | 2,86 \$            |
| 204397 | Fiş Priz Trio | 100      | 2,57 \$            |



## Uzatma

| Kod No | Cinsi                          | Koli Ad. | Uzatma Kabloları Serisi |
|--------|--------------------------------|----------|-------------------------|
| 204130 | Topraklı Uzatma 3 mt 3x1.0 mm  | 24       | 4,67 \$                 |
| 204131 | Topraklı Uzatma 5 mt 3x1.0 mm  | 50       | 6,30 \$                 |
| 204128 | Topraklı Uzatma 10 mt 3x1.5 mm | 25       | 9,63 \$                 |



**Keira Antibakteriyel Anahtar ve Priz Serisi**

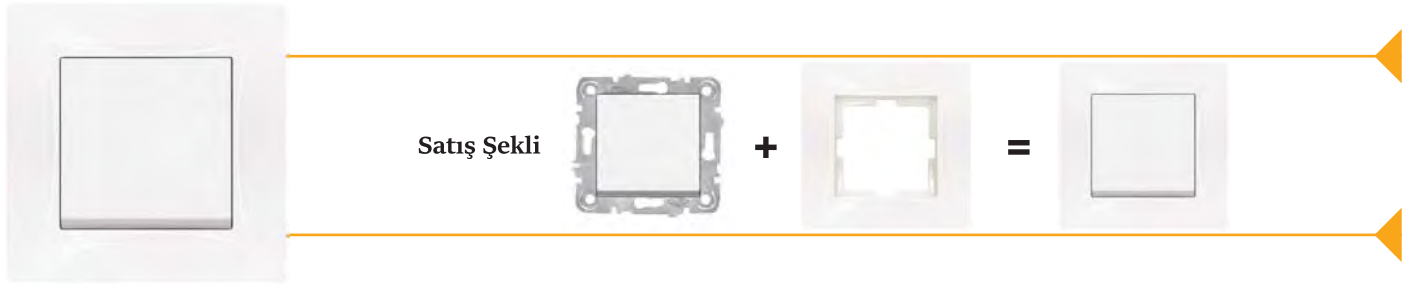
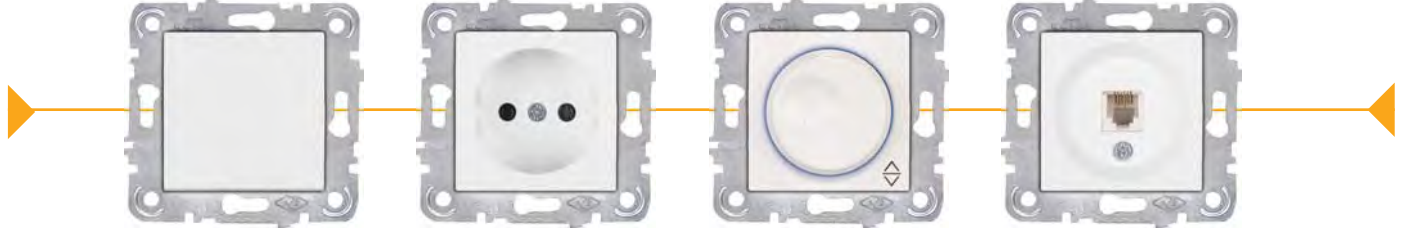

| Kod No                | Cinsi                                | Koli Ad. | Keira Antibakteriyel Seri |
|-----------------------|--------------------------------------|----------|---------------------------|
| <b>Anahtar Grubu</b>  |                                      |          |                           |
| 205157                | Anahtar                              | 120      | 1,58 \$                   |
| 205158                | Light                                | 120      | 1,63 \$                   |
| 205159                | Kapı otomatığı                       | 120      | 1,63 \$                   |
| 205160                | Zil anahtarı                         | 120      | 1,63 \$                   |
| 205161                | Komitatör                            | 120      | 1,93 \$                   |
| 205162                | Vavien                               | 120      | 1,87 \$                   |
| 205163                | Permitatör                           | 120      | 2,57 \$                   |
| 205164                | Komitatör vavien                     | 120      | 2,57 \$                   |
| 205165                | Jaluzi anahtarı                      | 120      | 2,45 \$                   |
| 205166                | Şofben anahtarı                      | 120      | 2,68 \$                   |
| 205167                | 3'lü anahtar                         | 120      | 3,44 \$                   |
| <b>Priz Grubu</b>     |                                      |          |                           |
| 205168                | Priz                                 | 120      | 1,46 \$                   |
| 205169                | Topraklı priz                        | 120      | 1,87 \$                   |
| 205170                | Çocuk korumalı topraklı priz         | 120      | 2,33 \$                   |
| 205171                | UPS topraklı priz                    | 120      | 2,22 \$                   |
| 205172                | UPS çocuk korumalı topraklı priz     | 120      | 2,45 \$                   |
| 205173                | Kapaklı topraklı priz                | 120      | 2,39 \$                   |
| 205174                | Çocuk korumalı kapaklı topraklı priz | 120      | 2,57 \$                   |
| 205175                | UPS kapaklı topraklı priz            | 120      | 2,45 \$                   |
| <b>TV/Radyo Grubu</b> |                                      |          |                           |
| 205176                | TV priz geçişli                      | 120      | 3,33 \$                   |
| 205177                | TV priz sonlu                        | 120      | 3,33 \$                   |
| 205178                | TV priz dirençsiz                    | 120      | 3,33 \$                   |
| 205179                | Uydu prizi F komnektörlü geçişli     | 120      | 3,79 \$                   |
| 205180                | Uydu prizi F komnektörlü sonlu       | 120      | 3,79 \$                   |
| 205181                | TV - Radyo priz geçişli              | 120      | 9,98 \$                   |
| 205182                | TV - Radyo priz sonlu                | 120      | 9,98 \$                   |
| 205183                | TV - Sat priz geçişli                | 120      | 10,38 \$                  |
| 205184                | TV - Sat priz sonlu                  | 120      | 10,38 \$                  |

| Kod No                      | Cinsi                          | Koli Ad. | Keira Antibakteriyel Seri |
|-----------------------------|--------------------------------|----------|---------------------------|
| <b>iletişim Grubu</b>       |                                |          |                           |
| 205186                      | Numeris telefon prizi (RJ11)   | 120      | 1,81 \$                   |
| 205187                      | İkili numeris (RJ11)           | 120      | 2,39 \$                   |
| 205188                      | Data numeris (RJ45CAT5-RJ11)   | 120      | 5,89 \$                   |
| 205189                      | Data priz (RJ45CAT5)           | 120      | 4,78 \$                   |
| 205190                      | İkili data priz (RJ45CAT5)     | 120      | 7,23 \$                   |
| 205191                      | Data jaksız                    | 120      | 1,93 \$                   |
| 205192                      | Data priz (RJ45CAT6)           | 120      | 4,78 \$                   |
| 205193                      | İkili data priz (RJ45CAT6)     | 120      | 8,11 \$                   |
| 205194                      | Data - Numeris (RJ45CAT6-RJ11) | 120      | 5,89 \$                   |
| 205195                      | Müzik Yayın Prizi              | 80       | 10,44 \$                  |
| 205196                      | VGA Prizi                      | 80       | 14,29 \$                  |
| 205201                      | Müzik yayın anahtarı           | 80       | 8,87 \$                   |
| <b>Dimmer Grubu</b>         |                                |          |                           |
| 205197                      | Dimmer 600W                    | 80       | 9,63 \$                   |
| 205198                      | Dimmer 1000W                   | 80       | 13,53 \$                  |
| 205199                      | Dimmer vavien 600W             | 80       | 17,03 \$                  |
| 205200                      | Dimmer RC 300W                 | 80       | 22,52 \$                  |
| <b>Işıklı Anahtar Grubu</b> |                                |          |                           |
| 205202                      | Işıklı anahtar                 | 120      | 2,63 \$                   |
| 205203                      | Işıklı light                   | 120      | 2,57 \$                   |
| 205204                      | Işıklı komitatör               | 120      | 3,03 \$                   |
| 205205                      | Işıklı vavien                  | 120      | 2,74 \$                   |
| 205206                      | Işıklı etiketli zil            | 120      | 2,74 \$                   |
| 205207                      | Işıklı dimmer 600W             | 80       | 10,68 \$                  |
| 205208                      | Işıklı dimmer 1000W            | 80       | 14,58 \$                  |
| 205209                      | Işıklı dimmer vavien 600W      | 80       | 18,08 \$                  |
| 205210                      | Işıklı dimmer RC 300W          | 80       | 23,57 \$                  |
| <b>Çerçeveler</b>           |                                |          |                           |
| 205320                      | 1'li çerçeve                   | 200      | 0,20 \$                   |
| 205321                      | 2'li çerçeve yatay-dikey       | 200      | 0,91 \$                   |
| 205322                      | 3'lü çerçeve yatay-dikey       | 150      | 1,23 \$                   |
| 205323                      | 4'lü çerçeve yatay-dikey       | 50       | 1,67 \$                   |
| 205324                      | 5'li çerçeve yatay-dikey       | 50       | 1,96 \$                   |
| 205325                      | 6'lı çerçeve yatay-dikey       | 50       | 2,54 \$                   |

## Keira Beyaz Anahtar ve Priz Serisi

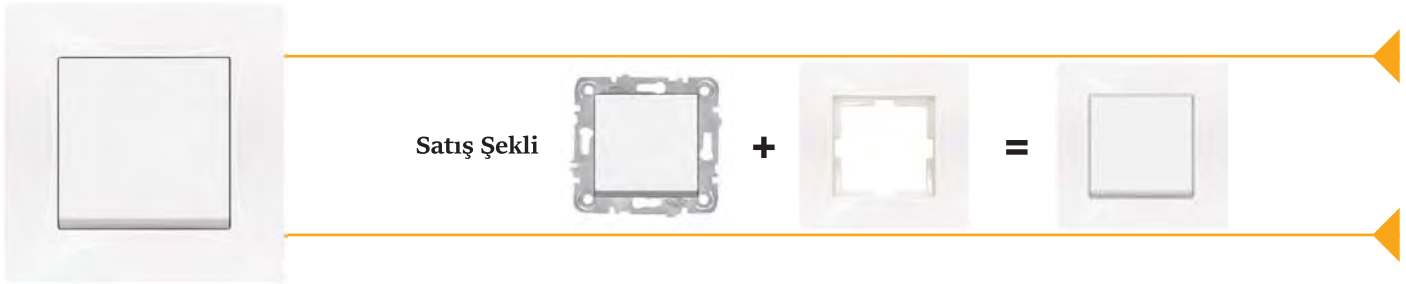
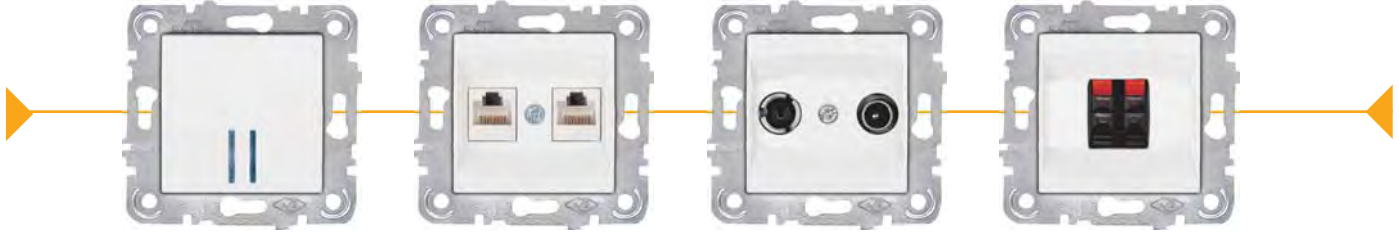

| Kod No                | Cinsi                                | Koli Ad. | Keira Beyaz & Krem Seri |
|-----------------------|--------------------------------------|----------|-------------------------|
| <b>Anahtar Grubu</b>  |                                      |          |                         |
| 202558                | Anahtar                              | 120      | 1,40 \$                 |
| 204991                | Light                                | 120      | 1,46 \$                 |
| 204992                | Kapı otomatığı                       | 120      | 1,46 \$                 |
| 204993                | Zil anahtar                          | 120      | 1,46 \$                 |
| 202561                | Komitatör                            | 120      | 1,75 \$                 |
| 204994                | Vavien                               | 120      | 1,69 \$                 |
| 204995                | Permitatör                           | 120      | 2,39 \$                 |
| 204996                | Komitatör vavien                     | 120      | 2,39 \$                 |
| 204997                | Jaluzi anahtarı                      | 120      | 2,28 \$                 |
| 204998                | Şofben anahtarı                      | 120      | 2,51 \$                 |
| 204999                | 3'lü anahtar                         | 120      | 3,27 \$                 |
| <b>Priz Grubu</b>     |                                      |          |                         |
| 205000                | Priz                                 | 120      | 1,28 \$                 |
| 202563                | Topraklı priz                        | 120      | 1,69 \$                 |
| 205001                | Çocuk korumalı topraklı priz         | 120      | 2,16 \$                 |
| 205002                | UPS topraklı priz                    | 120      | 2,04 \$                 |
| 205153                | UPS çocuk korumalı topraklı priz     | 120      | 2,28 \$                 |
| 205004                | Kapaklı topraklı priz                | 120      | 2,22 \$                 |
| 205154                | Çocuk korumalı kapaklı topraklı priz | 120      | 2,39 \$                 |
| 205006                | UPS kapaklı topraklı priz            | 120      | 2,28 \$                 |
| <b>TV/Radyo Grubu</b> |                                      |          |                         |
| 205009                | TV priz geçişli                      | 120      | 3,15 \$                 |
| 205010                | TV priz sonlu                        | 120      | 3,15 \$                 |
| 205011                | TV priz dirençsiz                    | 120      | 3,15 \$                 |
| 205012                | Uydu prizi F konnektörlü geçişli     | 120      | 3,62 \$                 |
| 205013                | Uydu prizi F konnektörlü sonlu       | 120      | 3,62 \$                 |
| 205014                | TV - Radyo priz geçişli              | 120      | 9,80 \$                 |
| 205015                | TV - Radyo priz sonlu                | 120      | 9,80 \$                 |
| 205016                | TV - Sat priz geçişli                | 120      | 10,21 \$                |
| 205007                | TV - Sat priz sonlu                  | 120      | 10,21 \$                |

| Kod No                      | Cinsi                          | Koli Ad. | Keira Beyaz & Krem Seri |
|-----------------------------|--------------------------------|----------|-------------------------|
| <b>iletışim Grubu</b>       |                                |          |                         |
| 205008                      | Numeris telefon prizi (RJ11)   | 120      | 1,63 \$                 |
| 205017                      | İkili numeris (RJ11)           | 120      | 2,22 \$                 |
| 205018                      | Data numeris (RJ45CAT5-RJ11)   | 120      | 5,72 \$                 |
| 205022                      | Data priz (RJ45CAT5)           | 120      | 4,61 \$                 |
| 205020                      | İkili data priz (RJ45CAT5)     | 120      | 7,06 \$                 |
| 205021                      | Data jaksız                    | 120      | 1,75 \$                 |
| 205022                      | Data priz (RJ45CAT6)           | 120      | 4,61 \$                 |
| 205023                      | İkili data priz (RJ45CAT6)     | 120      | 7,93 \$                 |
| 205024                      | Data - Numeris (RJ45CAT6-RJ11) | 120      | 5,72 \$                 |
| 205025                      | Müzik Yayın Prizi              | 80       | 9,28 \$                 |
| 205026                      | VGA Prizi                      | 80       | 14,12 \$                |
| 205031                      | Müzik yayın anahtarı           | 80       | 8,69 \$                 |
| <b>Dimmer Grubu</b>         |                                |          |                         |
| 205027                      | Dimmer 600W                    | 80       | 9,45 \$                 |
| 205028                      | Dimmer 1000W                   | 80       | 13,36 \$                |
| 205029                      | Dimmer vavien 600W             | 80       | 16,86 \$                |
| 205030                      | Dimmer RC 300W                 | 80       | 22,34 \$                |
| <b>Işıklı Anahtar Grubu</b> |                                |          |                         |
| 205032                      | Işıklı anahtar                 | 120      | 2,45 \$                 |
| 205033                      | Işıklı light                   | 120      | 2,39 \$                 |
| 205034                      | Işıklı komitatör               | 120      | 2,86 \$                 |
| 205035                      | Işıklı vavien                  | 120      | 2,57 \$                 |
| 205036                      | Işıklı etiketli zil            | 120      | 2,57 \$                 |
| 205037                      | Işıklı dimmer 600W             | 80       | 10,50 \$                |
| 205038                      | Işıklı dimmer 1000W            | 80       | 14,41 \$                |
| 205039                      | Işıklı dimmer vavien 600W      | 80       | 17,91 \$                |
| 205040                      | Işıklı dimmer RC 300W          | 80       | 23,33 \$                |
| <b>Çerçeveler</b>           |                                |          |                         |
| 205296                      | 1'li çerçeve                   | 200      | 0,20 \$                 |
| 205297                      | 2'li çerçeve yatay-dikey       | 200      | 0,76 \$                 |
| 205298                      | 3'lü çerçeve yatay-dikey       | 150      | 1,05 \$                 |
| 205299                      | 4'lü çerçeve yatay-dikey       | 50       | 1,46 \$                 |
| 205300                      | 5'li çerçeve yatay-dikey       | 50       | 1,69 \$                 |
| 205301                      | 6'li çerçeve yatay-dikey       | 50       | 2,22 \$                 |

**Keira Füme Anahtar ve Priz Serisi**

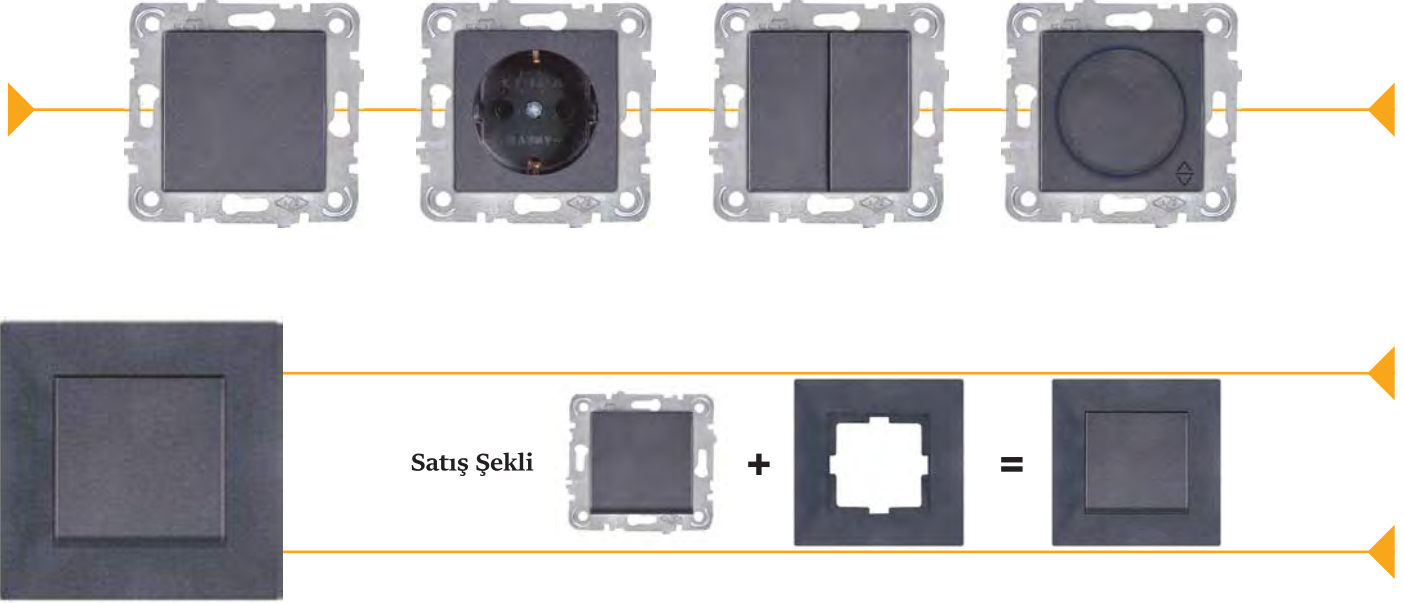

| Kod No                | Cinsi                                | Koli Ad. | Keira Metalik Seri |
|-----------------------|--------------------------------------|----------|--------------------|
| <b>Anahtar Grubu</b>  |                                      |          |                    |
| 205041                | Anahtar                              | 120      | 2,16 \$            |
| 205042                | Light                                | 120      | 2,22 \$            |
| 205043                | Kapı otomatığı                       | 120      | 2,22 \$            |
| 205044                | Zil anahtarı                         | 120      | 2,22 \$            |
| 205045                | Komitatör                            | 120      | 2,51 \$            |
| 205046                | Vavien                               | 120      | 2,45 \$            |
| 205047                | Permitatör                           | 120      | 3,03 \$            |
| 205048                | Komitatör vavien                     | 120      | 3,09 \$            |
| 205049                | Jaluzi anahtarı                      | 120      | 2,98 \$            |
| 205050                | Şofben anahtarı                      | 120      | 3,27 \$            |
| 205051                | 3'lü anahtar                         | 120      | 3,97 \$            |
| <b>Priz Grubu</b>     |                                      |          |                    |
| 205052                | Priz                                 | 120      | 2,28 \$            |
| 205053                | Topraklı priz                        | 120      | 2,68 \$            |
| 205056                | Çocuk korumalı topraklı priz         | 120      | 3,21 \$            |
| 205055                | UPS topraklı priz                    | 120      | 3,03 \$            |
| 205155                | UPS çocuk korumalı topraklı priz     | 120      | 3,33 \$            |
| 205057                | Kapaklı topraklı priz                | 120      | 3,27 \$            |
| 205058                | Çocuk korumalı kapaklı topraklı priz | 120      | 3,38 \$            |
| 205059                | UPS kapaklı topraklı priz            | 120      | 3,27 \$            |
| <b>TV/Radyo Grubu</b> |                                      |          |                    |
| 205060                | TV priz geçişli                      | 120      | 4,20 \$            |
| 205061                | TV priz sonlu                        | 120      | 4,20 \$            |
| 205062                | TV priz dirençsiz                    | 120      | 4,20 \$            |
| 205063                | Uydu prizi F konnektörlü geçişli     | 120      | 4,67 \$            |
| 205064                | Uydu prizi F konnektörlü sonlu       | 120      | 4,67 \$            |
| 205065                | TV - Radyo priz geçişli              | 120      | 10,91 \$           |
| 205066                | TV - Radyo priz sonlu                | 120      | 10,91 \$           |
| 205067                | TV - Sat priz geçişli                | 120      | 11,38 \$           |
| 205068                | TV - Sat priz sonlu                  | 120      | 11,38 \$           |

| Kod No                      | Cinsi                          | Koli Ad. | Keira Metalik Seri |
|-----------------------------|--------------------------------|----------|--------------------|
| <b>İletişim Grubu</b>       |                                |          |                    |
| 205070                      | Numeris telefon prizi (RJ11)   | 120      | 2,68 \$            |
| 205071                      | İkili numeris (RJ11)           | 120      | 2,68 \$            |
| 205072                      | Data numeris (RJ45CAT5-RJ11)   | 120      | 6,77 \$            |
| 205073                      | Data priz (RJ45CAT5)           | 120      | 5,66 \$            |
| 205074                      | İkili data priz (RJ45CAT5)     | 120      | 7,35 \$            |
| 205075                      | Data jaksız                    | 120      | 2,74 \$            |
| 205076                      | Data priz (RJ45CAT6)           | 120      | 5,66 \$            |
| 205077                      | İkili data priz (RJ45CAT6)     | 120      | 7,35 \$            |
| 205078                      | Data - Numeris (RJ45CAT6-RJ11) | 120      | 6,77 \$            |
| 205079                      | Müzik Yayın Prizi              | 80       | 10,44 \$           |
| 205080                      | VGA Prizi                      | 80       | 15,11 \$           |
| 205087                      | Müzik yayın anahtarı           | 80       | 9,80 \$            |
| <b>Dimmer Grubu</b>         |                                |          |                    |
| 205081                      | Dimmer 600W                    | 80       | 9,86 \$            |
| 205082                      | Dimmer 1000W                   | 80       | 14,58 \$           |
| 205085                      | Dimmer vavien 600W             | 80       | 18,08 \$           |
| 205086                      | Dimmer RC 300W                 | 80       | 23,63 \$           |
| <b>İşıkli Anahtar Grubu</b> |                                |          |                    |
| 205088                      | İşıkli anahtar                 | 120      | 3,38 \$            |
| 205089                      | İşıkli light                   | 120      | 3,44 \$            |
| 205090                      | İşıkli komitatör               | 120      | 3,73 \$            |
| 205091                      | İşıkli vavien                  | 120      | 3,62 \$            |
| 205092                      | İşıkli etiketli zil            | 120      | 3,44 \$            |
| 205093                      | İşıkli dimmer 600W             | 80       | 10,27 \$           |
| 205094                      | İşıkli dimmer 1000W            | 80       | 15,28 \$           |
| 205095                      | İşıkli dimmer vavien 600W      | 80       | 18,38 \$           |
| 205096                      | İşıkli dimmer RC 300W          | 80       | 24,21 \$           |
| <b>Çerçeveler</b>           |                                |          |                    |
| 205308                      | 1'li çerçeve                   | 200      | 0,64 \$            |
| 205309                      | 2'li çerçeve yatay-dikey       | 200      | 1,40 \$            |
| 205310                      | 3'lü çerçeve yatay-dikey       | 150      | 1,79 \$            |
| 205311                      | 4'lü çerçeve yatay-dikey       | 50       | 2,28 \$            |
| 205312                      | 5'li çerçeve yatay-dikey       | 50       | 2,60 \$            |
| 205313                      | 6'li çerçeve yatay-dikey       | 50       | 3,30 \$            |

## Keira Kiraz Anahtar ve Priz Serisi



Satış Şekli



+



=



| Kod No                | Cinsi                                | Koli Ad. | Keira Aşşap Seri |
|-----------------------|--------------------------------------|----------|------------------|
| <b>Anahtar Grubu</b>  |                                      |          |                  |
| 205097                | Anahtar                              | 120      | 2,16 \$          |
| 205098                | Light                                | 120      | 2,22 \$          |
| 205099                | Kapı otomatığı                       | 120      | 2,22 \$          |
| 205100                | Zil anahtarı                         | 120      | 2,22 \$          |
| 205101                | Komitatör                            | 120      | 2,51 \$          |
| 205102                | Vavien                               | 120      | 2,45 \$          |
| 205103                | Permitatör                           | 120      | 3,03 \$          |
| 205104                | Komitatör vavien                     | 120      | 3,09 \$          |
| 205105                | Jaluzi anahtarı                      | 120      | 2,98 \$          |
| 205106                | Şofben anahtarı                      | 120      | 3,27 \$          |
| 205107                | 3'lü anahtar                         | 120      | 3,97 \$          |
| <b>Priz Grubu</b>     |                                      |          |                  |
| 205108                | Priz                                 | 120      | 2,28 \$          |
| 205109                | Topraklı priz                        | 120      | 2,68 \$          |
| 205110                | Çocuk korumalı topraklı priz         | 120      | 3,21 \$          |
| 205111                | UPS topraklı priz                    | 120      | 3,03 \$          |
| 205112                | UPS çocuk korumalı topraklı priz     | 120      | 3,33 \$          |
| 205113                | Kapaklı topraklı priz                | 120      | 3,27 \$          |
| 205156                | Çocuk korumalı kapaklı topraklı priz | 120      | 3,38 \$          |
| 205115                | UPS kapaklı topraklı priz            | 120      | 3,27 \$          |
| <b>TV/Radyo Grubu</b> |                                      |          |                  |
| 205116                | TV priz geçişli                      | 120      | 4,20 \$          |
| 205118                | TV priz sonlu                        | 120      | 4,20 \$          |
| 205119                | TV priz dirençsiz                    | 120      | 4,20 \$          |
| 205120                | Uydu prizi F komnektörlü geçişli     | 120      | 4,67 \$          |
| 205121                | Uydu prizi F komnektörlü sonlu       | 120      | 4,67 \$          |
| 205122                | TV - Radyo priz geçişli              | 120      | 10,91 \$         |
| 205123                | TV - Radyo priz sonlu                | 120      | 10,91 \$         |
| 205124                | TV - Sat priz geçişli                | 120      | 11,38 \$         |
| 205125                | TV - Sat priz sonlu                  | 120      | 11,38 \$         |

| Kod No                      | Cinsi                          | Koli Ad. | Keira Aşşap Seri |
|-----------------------------|--------------------------------|----------|------------------|
| <b>iletifim Grubu</b>       |                                |          |                  |
| 205126                      | Numeris telefon prizi (RJ11)   | 120      | 2,68 \$          |
| 205127                      | İkili numeris (RJ11)           | 120      | 2,68 \$          |
| 205128                      | Data numeris (RJ45CAT5-RJ11)   | 120      | 6,77 \$          |
| 205129                      | Data priz (RJ45CAT5)           | 120      | 5,66 \$          |
| 205130                      | İkili data priz (RJ45CAT5)     | 120      | 7,35 \$          |
| 205131                      | Data jaksız                    | 120      | 2,74 \$          |
| 205132                      | Data priz (RJ45CAT6)           | 120      | 5,66 \$          |
| 205133                      | İkili data priz (RJ45CAT6)     | 120      | 7,35 \$          |
| 205134                      | Data - Numeris (RJ45CAT6-RJ11) | 120      | 6,77 \$          |
| 205135                      | Müzik Yayın Prizi              | 80       | 10,44 \$         |
| 205136                      | VGA Prizi                      | 80       | 15,11 \$         |
| 205141                      | Müzik yayın anahtarı           | 80       | 9,80 \$          |
| <b>Dimmer Grubu</b>         |                                |          |                  |
| 205137                      | Dimmer 600W                    | 80       | 9,86 \$          |
| 205138                      | Dimmer 1000W                   | 80       | 14,58 \$         |
| 205139                      | Dimmer vavien 600W             | 80       | 18,08 \$         |
| 205140                      | Dimmer RC 300W                 | 80       | 23,63 \$         |
| <b>İşiklı Anahtar Grubu</b> |                                |          |                  |
| 205142                      | İşiklı anahtar                 | 120      | 3,38 \$          |
| 205143                      | İşiklı light                   | 120      | 3,44 \$          |
| 205144                      | İşiklı komitatör               | 120      | 3,73 \$          |
| 205145                      | İşiklı vavien                  | 120      | 3,62 \$          |
| 205146                      | İşiklı etiketli zil            | 120      | 3,44 \$          |
| 205147                      | İşiklı dimmer 600W             | 80       | 10,27 \$         |
| 205148                      | İşiklı dimmer 1000W            | 80       | 15,28 \$         |
| 205149                      | İşiklı dimmer vavien 600W      | 80       | 18,38 \$         |
| 205150                      | İşiklı dimmer RC 300W          | 80       | 24,21 \$         |
| <b>Çerçeveler</b>           |                                |          |                  |
| 205314                      | 1'li çerçeve                   | 200      | 0,64 \$          |
| 205315                      | 2'li çerçeve yatay-dikey       | 200      | 1,40 \$          |
| 205316                      | 3'lü çerçeve yatay-dikey       | 150      | 1,79 \$          |
| 205317                      | 4'lü çerçeve yatay-dikey       | 50       | 2,28 \$          |
| 205318                      | 5'li çerçeve yatay-dikey       | 50       | 2,60 \$          |
| 205319                      | 6'li çerçeve yatay-dikey       | 50       | 3,30 \$          |



**Keira Beyaz / Cam-Corian**

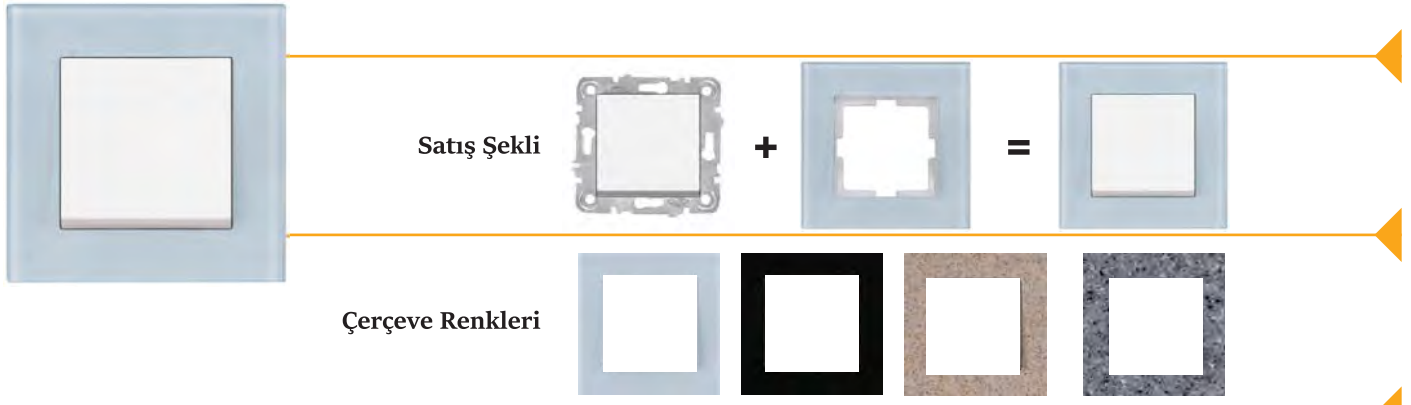
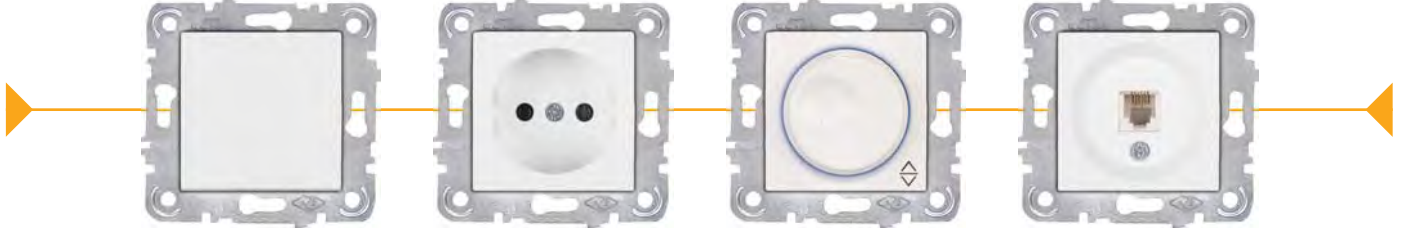

| Kod No                | Cinsi                                | Koli Ad. | Keira Metalik Seri |
|-----------------------|--------------------------------------|----------|--------------------|
| <b>Anahtar Grubu</b>  |                                      |          |                    |
| 202558                | Anahtar                              | 120      | 1,40 \$            |
| 204991                | Light                                | 120      | 1,46 \$            |
| 204992                | Kapı otomatığı                       | 120      | 1,46 \$            |
| 204993                | Zil anahtarı                         | 120      | 1,46 \$            |
| 202561                | Komitatör                            | 120      | 1,75 \$            |
| 204994                | Vavien                               | 120      | 1,69 \$            |
| 204995                | Permitatör                           | 120      | 2,39 \$            |
| 204996                | Komitatör vavien                     | 120      | 2,39 \$            |
| 204997                | Jaluzi anahtar                       | 120      | 2,28 \$            |
| 204998                | Şofben anahtarı                      | 120      | 2,51 \$            |
| 204999                | 3'lü anahtar                         | 120      | 3,27 \$            |
| <b>Priz Grubu</b>     |                                      |          |                    |
| 205000                | Priz                                 | 120      | 1,28 \$            |
| 202563                | Topraklı priz                        | 120      | 1,69 \$            |
| 205001                | Çocuk korumalı topraklı priz         | 120      | 2,16 \$            |
| 205002                | UPS topraklı priz                    | 120      | 2,04 \$            |
| 205153                | UPS çocuk korumalı topraklı priz     | 120      | 2,28 \$            |
| 205004                | Kapaklı topraklı priz                | 120      | 2,22 \$            |
| 205154                | Çocuk korumalı kapaklı topraklı priz | 120      | 2,39 \$            |
| 205006                | UPS kapaklı topraklı priz            | 120      | 2,28 \$            |
| <b>TV/Radyo Grubu</b> |                                      |          |                    |
| 205009                | TV priz geçişli                      | 120      | 3,15 \$            |
| 205010                | TV priz sonlu                        | 120      | 3,15 \$            |
| 205011                | TV priz dirençsiz                    | 120      | 3,15 \$            |
| 205012                | Uydu prizi F komnektörlü geçişli     | 120      | 3,62 \$            |
| 205013                | Uydu prizi F komnektörlü sonlu       | 120      | 3,62 \$            |
| 205014                | TV - Radyo priz geçişli              | 120      | 9,80 \$            |
| 205015                | TV - Radyo priz sonlu                | 120      | 9,80 \$            |
| 205016                | TV - Sat priz geçişli                | 120      | 10,21 \$           |
| 205007                | TV - Sat priz sonlu                  | 120      | 10,21 \$           |
| <b>Dimmer Grubu</b>   |                                      |          |                    |
| 205027                | Dimmer 600W                          | 80       | 9,45 \$            |
| 205028                | Dimmer 1000W                         | 80       | 13,36 \$           |
| 205029                | Dimmer vavien 600W                   | 80       | 16,86 \$           |
| 205030                | Dimmer RC 300W                       | 80       | 22,34 \$           |

| Kod No                      | Cinsi                          | Koli Ad. | Keira Metalik Seri |
|-----------------------------|--------------------------------|----------|--------------------|
| <b>İletişim Grubu</b>       |                                |          |                    |
| 205008                      | Numeris telefon prizi (RJ11)   | 120      | 1,63 \$            |
| 205017                      | İkili numeris (RJ11)           | 120      | 2,22 \$            |
| 205018                      | Data numeris (RJ45CAT5-RJ11)   | 120      | 5,72 \$            |
| 205022                      | Data priz (RJ45CAT5)           | 120      | 4,61 \$            |
| 205020                      | İkili data priz (RJ45CAT5)     | 120      | 7,06 \$            |
| 205021                      | Data jaksız                    | 120      | 1,75 \$            |
| 205022                      | Data priz (RJ45CAT6)           | 120      | 4,61 \$            |
| 205023                      | İkili data priz (RJ45CAT6)     | 120      | 7,93 \$            |
| 205024                      | Data - Numeris (RJ45CAT6-RJ11) | 120      | 5,72 \$            |
| 205025                      | Müzik Yayın Prizi              | 80       | 9,28 \$            |
| 205026                      | VGA Prizi                      | 80       | 14,12 \$           |
| 205031                      | Müzik yayın anahtarı           | 80       | 8,69 \$            |
| <b>Işıklı Anahtar Grubu</b> |                                |          |                    |
| 205032                      | Işıklı anahtar                 | 120      | 2,45 \$            |
| 205033                      | Işıklı light                   | 120      | 2,39 \$            |
| 205034                      | Işıklı komitatör               | 120      | 2,86 \$            |
| xxxxxx                      | Işıklı vavien                  | 120      | 2,57 \$            |
| 205036                      | Işıklı etiketli zil            | 120      | 2,57 \$            |
| 205037                      | Işıklı dimmer 600W             | 80       | 10,50 \$           |
| 205038                      | Işıklı dimmer 1000W            | 80       | 14,41 \$           |
| 205039                      | Işıklı dimmer vavien 600W      | 80       | 17,91 \$           |
| 205040                      | Işıklı dimmer RC 300W          | 80       | 23,33 \$           |
| <b>Çerçeveler</b>           |                                |          |                    |
| 310355                      | Beyaz cam tekli                | 400      | 9,33 \$            |
| 310356                      | Beyaz cam ikili                | 200      | 11,67 \$           |
| 310357                      | Beyaz cam üçlü                 | 150      | 14,00 \$           |
| 310358                      | Siyah cam tekli                | 400      | 9,33 \$            |
| 310359                      | Siyah cam ikili                | 200      | 11,67 \$           |
| 310360                      | Siyah cam üçlü                 | 150      | 14,00 \$           |
| 310361                      | Gri corian cam tekli           | 400      | 9,33 \$            |
| 310362                      | Gri corian cam ikili           | 200      | 11,67 \$           |
| 310363                      | Gri corian cam üçlü            | 150      | 14,00 \$           |
| 310364                      | Kahverengi corian cam tekli    | 400      | 9,33 \$            |
| 310365                      | Kahverengi corian cam ikili    | 200      | 11,67 \$           |
| 310366                      | Kahverengi corian cam üçlü     | 150      | 14,00 \$           |



## Keira Füme / Cam-Corian

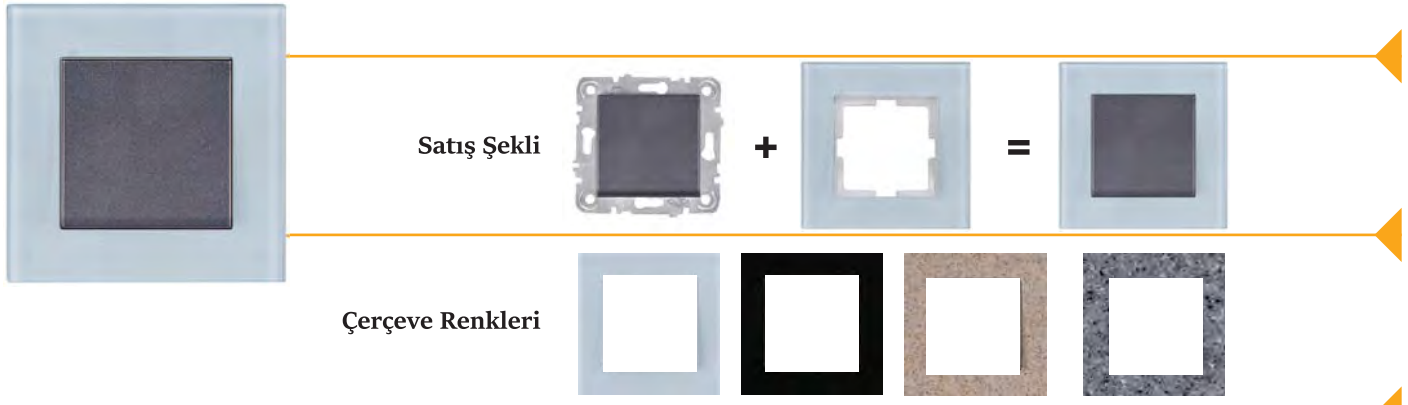
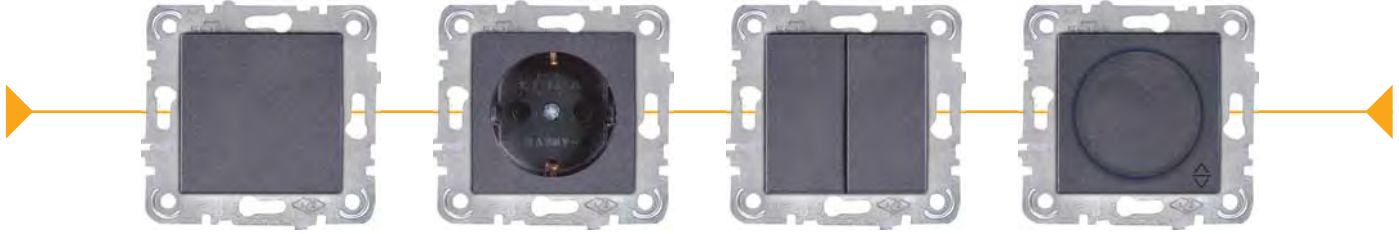

| Kod No                | Cinsi                                | Koli Ad. | Keira Metalik Seri |
|-----------------------|--------------------------------------|----------|--------------------|
| <b>Anahtar Grubu</b>  |                                      |          |                    |
| 205041                | Anahtar                              | 120      | 2,16 \$            |
| 205042                | Light                                | 120      | 2,22 \$            |
| 205043                | Kapı otomatığı                       | 120      | 2,22 \$            |
| 205044                | Zil anahtarı                         | 120      | 2,22 \$            |
| 205045                | Komitatör                            | 120      | 2,51 \$            |
| 205046                | Vavien                               | 120      | 2,45 \$            |
| 205047                | Permitatör                           | 120      | 3,03 \$            |
| 205048                | Komitatör vavien                     | 120      | 3,09 \$            |
| 205049                | Jaluzi anahtarı                      | 120      | 2,98 \$            |
| 205050                | Şofben anahtarı                      | 120      | 3,27 \$            |
| 205051                | 3'lü anahtar                         | 120      | 3,97 \$            |
| <b>Priz Grubu</b>     |                                      |          |                    |
| 205052                | Priz                                 | 120      | 2,28 \$            |
| 205053                | Topraklı priz                        | 120      | 2,68 \$            |
| 205056                | Çocuk korumalı topraklı priz         | 120      | 3,21 \$            |
| 205055                | UPS topraklı priz                    | 120      | 3,03 \$            |
| 205155                | UPS çocuk korumalı topraklı priz     | 120      | 3,33 \$            |
| 205057                | Kapaklı topraklı priz                | 120      | 3,27 \$            |
| 205058                | Çocuk korumalı kapaklı topraklı priz | 120      | 3,38 \$            |
| 205059                | UPS kapaklı topraklı priz            | 120      | 3,27 \$            |
| <b>TV/Radyo Grubu</b> |                                      |          |                    |
| 205060                | TV priz geçişli                      | 120      | 4,20 \$            |
| 205061                | TV priz sonlu                        | 120      | 4,20 \$            |
| 205062                | TV priz dirençsiz                    | 120      | 4,20 \$            |
| 205063                | Uydu prizi F komnektörlü geçişi      | 120      | 4,67 \$            |
| 205064                | Uydu prizi F komnektörlü sonlu       | 120      | 4,67 \$            |
| 205065                | TV - Radyo priz geçişli              | 120      | 10,91 \$           |
| 205066                | TV - Radyo priz sonlu                | 120      | 10,91 \$           |
| 205067                | TV - Sat priz geçişli                | 120      | 11,38 \$           |
| 205068                | TV - Sat priz sonlu                  | 120      | 11,38 \$           |
| <b>Dimmer Grubu</b>   |                                      |          |                    |
| 205081                | Dimmer 600W                          | 80       | 9,86 \$            |
| 205082                | Dimmer 1000W                         | 80       | 14,58 \$           |
| 205085                | Dimmer vavien 600W                   | 80       | 18,08 \$           |
| 205086                | Dimmer RC 300W                       | 80       | 23,63 \$           |

| Kod No                      | Cinsi                          | Koli Ad. | Keira Metalik Seri |
|-----------------------------|--------------------------------|----------|--------------------|
| <b>İletişim Grubu</b>       |                                |          |                    |
| 205070                      | Numeris telefon prizi (RJ11)   | 120      | 2,68 \$            |
| 205071                      | İkili numeris (RJ11)           | 120      | 2,68 \$            |
| 205072                      | Data numeris (RJ45CAT5-RJ11)   | 120      | 6,77 \$            |
| 205073                      | Data priz (RJ45CAT5)           | 120      | 5,66 \$            |
| 205074                      | İkili data priz (RJ45CAT5)     | 120      | 7,35 \$            |
| 205075                      | Data jaksız                    | 120      | 2,74 \$            |
| 205076                      | Data priz (RJ45CAT6)           | 120      | 5,66 \$            |
| 205077                      | İkili data priz (RJ45CAT6)     | 120      | 7,35 \$            |
| 205078                      | Data - Numeris (RJ45CAT6-RJ11) | 120      | 6,77 \$            |
| 205079                      | Müzik Yayın Prizi              | 80       | 10,44 \$           |
| 205080                      | VGA Prizi                      | 80       | 15,11 \$           |
| 205087                      | Müzik yayın anahtarı           | 80       | 9,80 \$            |
| <b>Işıklı Anahtar Grubu</b> |                                |          |                    |
| 205088                      | Işıklı anahtar                 | 120      | 3,38 \$            |
| 205089                      | Işıklı light                   | 120      | 3,44 \$            |
| 205090                      | Işıklı komitatör               | 120      | 3,73 \$            |
| 205091                      | Işıklı vavien                  | 120      | 3,62 \$            |
| 205092                      | Işıklı etiketli zil            | 120      | 3,44 \$            |
| 205093                      | Işıklı dimmer 600W             | 80       | 10,27 \$           |
| 205094                      | Işıklı dimmer 1000W            | 80       | 15,28 \$           |
| 205095                      | Işıklı dimmer vavien 600W      | 80       | 18,38 \$           |
| 205096                      | Işıklı dimmer RC 300W          | 80       | 24,21 \$           |
| <b>Çerçeveler</b>           |                                |          |                    |
| 310355                      | Beyaz cam tekli                | 400      | 9,33 \$            |
| 310356                      | Beyaz cam ikili                | 200      | 11,67 \$           |
| 310357                      | Beyaz cam üçlü                 | 150      | 14,00 \$           |
| 310358                      | Siyah cam tekli                | 400      | 9,33 \$            |
| 310359                      | Siyah cam ikili                | 200      | 11,67 \$           |
| 310360                      | Siyah cam üçlü                 | 150      | 14,00 \$           |
| 310361                      | Gri corian cam tekli           | 400      | 9,33 \$            |
| 310362                      | Gri corian cam ikili           | 200      | 11,67 \$           |
| 310363                      | Gri corian cam üçlü            | 150      | 14,00 \$           |
| 310364                      | Kahverengi corian cam tekli    | 400      | 9,33 \$            |
| 310365                      | Kahverengi corian cam ikili    | 200      | 11,67 \$           |
| 310366                      | Kahverengi corian cam üçlü     | 150      | 14,00 \$           |



### Euro 1000W Simetrik Alüminyum Enjeksiyon



IP 65

| Kod No | Özellikler          | Koli Adedi | Fiyat     |
|--------|---------------------|------------|-----------|
| 203884 | 1000 W Metal, HPI-T | 1          | 378,00 \$ |

### Shekelo Projektör



IP 65

| Kod No | Özellikler             | Koli Adedi | Fiyat    |
|--------|------------------------|------------|----------|
| 105229 | Shekelo 250W E40 MH/SB | 1          | 85,00 \$ |
| 105232 | Shekelo 400W E40 MH/SB | 1          | 90,00 \$ |

### Tünel 250-400W Alüminyum Enjeksiyon



IP 65

| Kod No | Özellikler     | Koli Adedi | Fiyat     |
|--------|----------------|------------|-----------|
| 104327 | 250W MH/SB E40 | 1          | 147,00 \$ |
| 204329 | 400W SB E40    | 1          | 153,00 \$ |

### Levoled Alüminyum Enjeksiyon



IP 65

| Kod No | Özellikler  | Koli Adedi | Fiyat    |
|--------|-------------|------------|----------|
| 107758 | 25W LevoLED | 4          | 87,80 \$ |

### RGB Projektör 36 LEDli



IP 65

| Kod No | Özellikler             | Koli Adedi | Fiyat     |
|--------|------------------------|------------|-----------|
| 204723 | RGB Projektör 36 LEDli | 1          | 167,70 \$ |

### LED Projektör Pole



IP 65

| Kod No | Özellikler | Koli Adedi | Fiyat    |
|--------|------------|------------|----------|
| 105822 | 72W 6500K  | 1          | 73,00 \$ |

### Leraled



IP 65

| Kod No | Özellikler | Koli Adedi | Fiyat   |
|--------|------------|------------|---------|
| 204444 | 10W 6500K  | 40         | 9,50 \$ |

### Duvar Gömme Armatürü Escaled

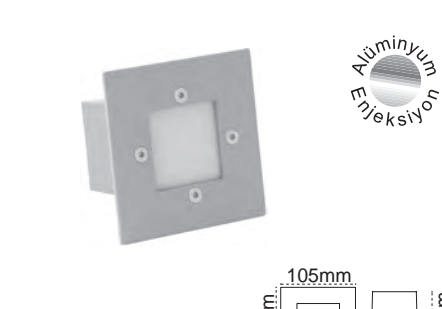

Alüminyum Enjeksiyon

IP 54

| Kod No | Özellikler     | Koli Adedi | Fiyat   |
|--------|----------------|------------|---------|
| 204446 | 12 LEDli 4000K | 50         | 6,15 \$ |

### Duvar Gömme Armatürü Escaled S

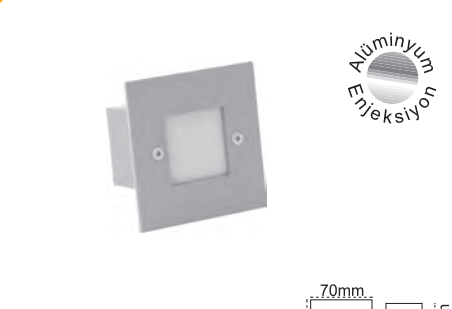

Alüminyum Enjeksiyon

IP 54

| Kod No | Özellikler    | Koli Adedi | Fiyat   |
|--------|---------------|------------|---------|
| 204445 | 9 LEDli 4000K | 50         | 6,15 \$ |

### Duvar Gömme Armatürü Piale

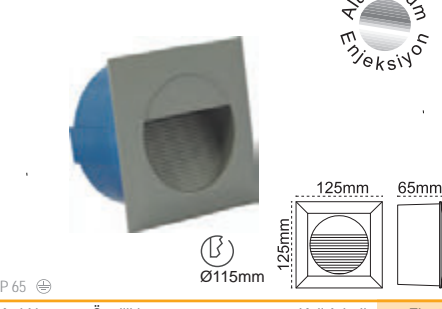

Alüminyum Enjeksiyon

IP 65

| Kod No | Özellikler     | Koli Adedi | Fiyat    |
|--------|----------------|------------|----------|
| 204441 | 14 LEDli 4000K | 24         | 15,90 \$ |

### Duvar Gömme Armatürü Dialed

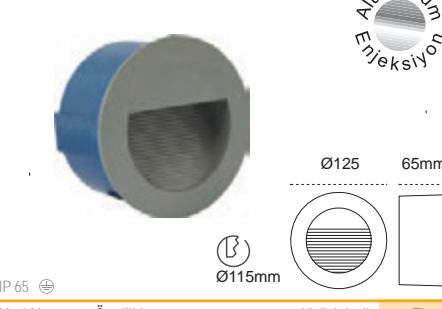

Alüminyum Enjeksiyon

IP 65

| Kod No | Özellikler     | Koli Adedi | Fiyat    |
|--------|----------------|------------|----------|
| 204442 | 14 LEDli 4000K | 24         | 15,90 \$ |

### Aplik Clubled



IP 44

| Kod No | Özellikler       | Koli Adedi | Fiyat   |
|--------|------------------|------------|---------|
| 204528 | LEDli Ilık Beyaz | 40         | 8,20 \$ |
| 204527 | LEDli Mavi       | 40         | 8,20 \$ |
| 204526 | LEDli Beyaz      | 40         | 8,20 \$ |

**Aplik Perle**



IP 20 ⊕

| Kod No | Özellikler | Koli Adedi | Fiyat   |
|--------|------------|------------|---------|
| 204525 | Aplik E27  | 20         | 8,20 \$ |

**Aplik Dora LED**



Alüminyum Enjeksiyon

IP 44 ⊕

| Kod No | Özellikler | Koli Adedi | Fiyat    |
|--------|------------|------------|----------|
| 204529 | 3W 4000K   | 24         | 16,50 \$ |

**Aplik/Bolard Corona**



IP 54 ⊕

| Kod No | Özellikler      | Koli Adedi | Fiyat    |
|--------|-----------------|------------|----------|
| 204516 | Aplik 6W 3000K  | 1          | 27,00 \$ |
| 204467 | Bolard 6W 3000K | 1          | 60,00 \$ |

**Aplik Işıglas 1**



Alüminyum Enjeksiyon

IP 44 ⊕

| Kod No | Özellikler  | Koli Adedi | Fiyat    |
|--------|-------------|------------|----------|
| 204507 | 1 Aplik E27 | 12         | 11,00 \$ |

**Çimen Armatürü Işıglas**



Alüminyum Enjeksiyon

IP 44 ⊕

| Kod No | Özellikler         | Koli Adedi | Fiyat    |
|--------|--------------------|------------|----------|
| 204429 | E27 Çimen Armatürü | 4          | 31,00 \$ |

**Çimen Armatürü Briled 3**

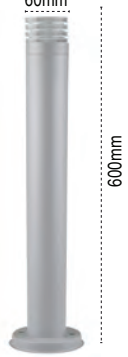

Alüminyum Gövde

IP 54 ⊕

| Kod No | Özellikler     | Koli Adedi | Fiyat    |
|--------|----------------|------------|----------|
| 203812 | 5W LEDli 4000K | 6          | 21,00 \$ |

**Çimen Armatürü Grassled**



Alüminyum Enjeksiyon

IP 65 ⊕

| Kod No | Özellikler      | Koli Adedi | Fiyat    |
|--------|-----------------|------------|----------|
| 203813 | 3W 6500K        | 20         | 16,80 \$ |
| 203816 | 3W Yeşil        | 20         | 16,80 \$ |
| 203814 | Saplama Aparatı | 1          | 4,00 \$  |

**Aplik Briled 1**



Alüminyum Gövde

IP 54 ⊕

| Kod No | Özellikler     | Koli Adedi | Fiyat    |
|--------|----------------|------------|----------|
| 204524 | 5W LEDli 4000K | 6          | 15,00 \$ |

**Wallwasher 18 LEDli**



IP 65 ⊕

| Kod No | Özellikler          | Koli Adedi | Fiyat    |
|--------|---------------------|------------|----------|
| 106397 | 18 LEDli 50cm Amber | 1          | 30,00 \$ |

**Duvar Gömme Armatürü Hatled**

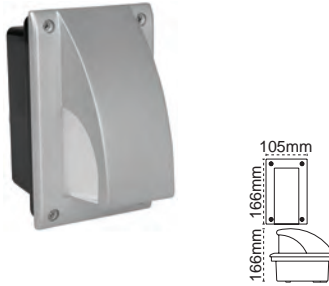

IP 44 ⊕

| Kod No | Özellikler  | Koli Adedi | Fiyat   |
|--------|-------------|------------|---------|
| 204531 | LEDli Beyaz | 12         | 6,15 \$ |
| 204530 | LEDli Mavi  | 12         | 6,15 \$ |

**Aplik Işıled 2**

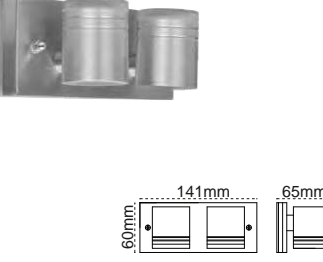

IP 44 ⊕

| Kod No | Özellikler       | Koli Adedi | Fiyat   |
|--------|------------------|------------|---------|
| 204473 | LEDli Ilık Beyaz | 24         | 8,50 \$ |
| 204472 | LEDli Mavi       | 24         | 8,50 \$ |

**Aplik Işıled 3**

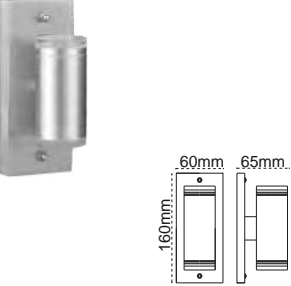

IP 44 ⊕

| Kod No | Özellikler | Koli Adedi | Fiyat   |
|--------|------------|------------|---------|
| 204474 | LEDli Mavi | 12         | 8,50 \$ |

### Gece Lambası



| Kod No | Özellikler | Koli Adedi | Fiyat   |
|--------|------------|------------|---------|
| 204611 | Roza Yeşil | 60         | 3,00 \$ |
| 204612 | Roza Amber | 60         | 4,00 \$ |
| 204600 | Beray      | 60         | 5,00 \$ |

### İşıldak 16 LEDli



| Kod No | Özellikler | Koli Adedi | Fiyat   |
|--------|------------|------------|---------|
| 204655 | 16 LEDli   | 30         | 6,15 \$ |

### Acil Aydınlatma Spotu

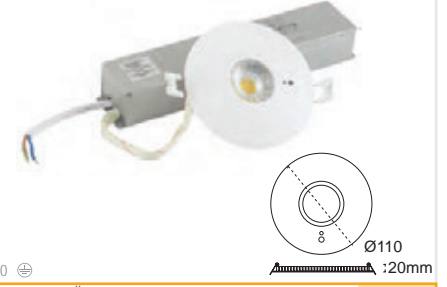

| Kod No | Özellikler      | Koli Adedi | Fiyat    |
|--------|-----------------|------------|----------|
| 204465 | 3W 6500K (2'li) | 20         | 33,80 \$ |

### Tasarruflu Lamba GU10 / G9 Duylu



| Kod No | Özellikler    | Koli Adedi | Fiyat   |
|--------|---------------|------------|---------|
| 313479 | 9W GU10 2700K | 60         | 1,15 \$ |
| 313480 | 9W G9 2700K   | 60         | 1,15 \$ |

### Tasarruflu Lamba E14 Duylu



| Kod No | Özellikler      | Koli Adedi | Fiyat   |
|--------|-----------------|------------|---------|
| 313500 | Maxin E14 2700K | 60         | 1,15 \$ |
| 313481 | Maxin E14 2700K | 60         | 1,15 \$ |

### Tasarruflu Lamba E27 Duylu



| Kod No | Özellikler    | Koli Adedi | Fiyat   |
|--------|---------------|------------|---------|
| 313490 | Maxin 45W E27 | 60         | 3,50 \$ |
| 313503 | Maxin 65W E27 | 60         | 4,70 \$ |

### T5 Floresan

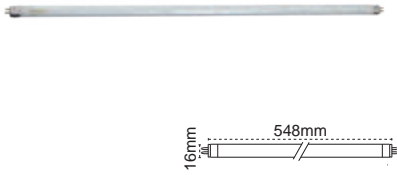

| Kod No | Özellikler            | Koli Adedi | Fiyat   |
|--------|-----------------------|------------|---------|
| 313367 | 35W T5 Floresan 4000K | 100        | 3,10 \$ |

### PLC Lamba

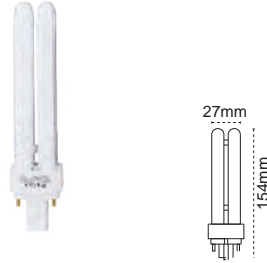

| Kod No | Özellikler            | Koli Adedi | Fiyat   |
|--------|-----------------------|------------|---------|
| 313339 | 18W PLC 4000K 4 Pinli | 100        | 1,00 \$ |
| 313338 | 26W PLC 4000K 4 Pinli | 100        | 1,00 \$ |

### Metal Lambalar G12

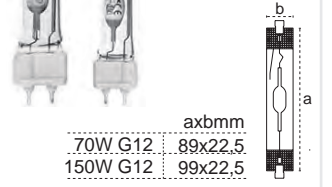

| Kod No | Özellikler     | Koli Adedi | Fiyat   |
|--------|----------------|------------|---------|
| 313519 | 70W 5500K G12  | 100        | 9,00 \$ |
| 313520 | 150W 5500K G12 | 100        | 9,00 \$ |
| 313521 | 70W 3000K G12  | 100        | 9,00 \$ |
| 313522 | 150W 3000K G12 | 100        | 9,00 \$ |

### Par Lamba



| Kod No | Özellikler                  | Koli Adedi | Fiyat    |
|--------|-----------------------------|------------|----------|
| 313408 | 12X1W PAR38 Lamba 4000K E27 | 20         | 10,40 \$ |
| 313409 | 12X1W PAR38 Lamba 6500K E27 | 20         | 10,40 \$ |

### MR 16



| Kod No | Özellikler       | Koli Adedi | Fiyat   |
|--------|------------------|------------|---------|
| 313388 | 3X1W 3000K GU5,3 | 200        | 1,70 \$ |
| 313387 | 3X1W 6500K GU5,3 | 200        | 1,70 \$ |

### Kapsül Lamba (G4-G9)

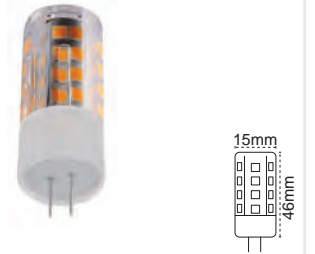

| Kod No | Özellikler              | Koli Adedi | Fiyat   |
|--------|-------------------------|------------|---------|
| 313460 | 3W Kapsül 3000K G9 220V | 100        | 2,00 \$ |
| 313461 | 3W Kapsül 3000K G4 220V | 100        | 2,00 \$ |
| 313459 | 3W Kapsül 3000K G4      | 100        | 2,00 \$ |

### Yer Gömme 20

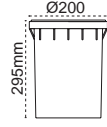

IP 65 ☺

| Kod No | Özellikler                | Koli Adedi | Fiyat     |
|--------|---------------------------|------------|-----------|
| 204264 | Yer Gömme 20 Boş          | 1          | 31,00 \$  |
| 105737 | Yer Gömme 12X1W LED 3000K | 1          | 162,80 \$ |

### Yer Gömme 25

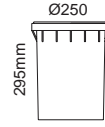

IP 65 ☺

| Kod No | Özellikler                  | Koli Adedi | Fiyat    |
|--------|-----------------------------|------------|----------|
| 204265 | Yer Gömme Asimetrik G12 Boş | 1          | 90,00 \$ |

### Yer Gömme Kare Asimetrik

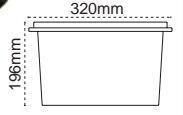

IP 65 ☺

| Kod No | Özellikler | Koli Adedi | Fiyat    |
|--------|------------|------------|----------|
| 107648 | RX7s       | 10         | 90,00 \$ |

### Yer Gömme Miniled 3'lü

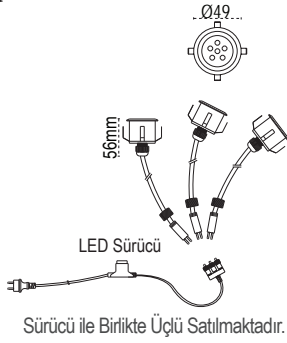

IP 65 ☺

| Kod No | Özellikler | Koli Adedi | Fiyat    |
|--------|------------|------------|----------|
| 204266 | LEDli Mavi | 12         | 25,00 \$ |

### Yuvarlak Yer Gömme Midiled 12

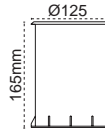

IP 65 ☺

| Kod No | Özellikler  | Koli Adedi | Fiyat    |
|--------|-------------|------------|----------|
| 204273 | LEDli 4000K | 18         | 25,00 \$ |

### Kare Yer Gömme Midiled 12

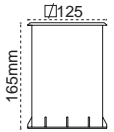

IP 65 ☺

| Kod No | Özellikler | Koli Adedi | Fiyat    |
|--------|------------|------------|----------|
| 204275 | LEDli Mavi | 18         | 25,00 \$ |

### Park Bahçe Direği Lilyum



IP 54 ☺

| Kod No | Özellikler | Koli Adedi | Fiyat     |
|--------|------------|------------|-----------|
| 203862 | İkili E27  | 1          | 105,00 \$ |

### Park Bahçe Direği Verde



IP 54 ☺

| Kod No | Özellikler            | Koli Adedi | Fiyat    |
|--------|-----------------------|------------|----------|
| 204246 | Verde LEDli 68W 6500K | 1          | 93,00 \$ |

### Park Bahçe Direği Sparta

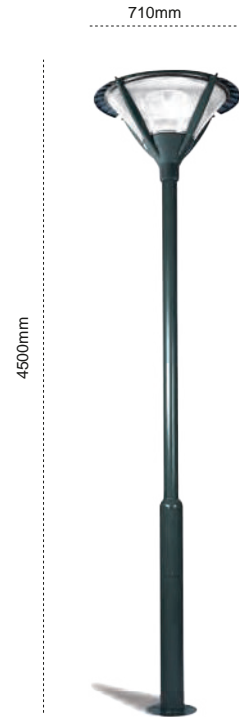

IP 65 ☺

| Kod No | Özellikler         | Koli Adedi | Fiyat     |
|--------|--------------------|------------|-----------|
| 104372 | Sparta MH 150W E40 | 1          | 285,00 \$ |

**Dekoratif Sarkıt Dekart**



IP 20 ☺

| Kod No | Özellikler | Koli Adedi | Fiyat    |
|--------|------------|------------|----------|
| 105078 | 2X28W T5   | 1          | 90,00 \$ |

**Dekoratif Sarkıt Menart**



IP 40 ☺

| Kod No | Özellikler | Koli Adedi | Fiyat    |
|--------|------------|------------|----------|
| 105084 | 2X28W T5   | 1          | 53,00 \$ |

**Dekoratif Sarkıt Artemis**



IP 40 ☺

| Kod No | Özellikler | Koli Adedi | Fiyat     |
|--------|------------|------------|-----------|
| 105080 | 3X35W T5   | 1          | 100,00 \$ |

**Tavan Armatürü Planet**



IP 20 ☺

| Kod No | Özellikler | Koli Adedi | Fiyat    |
|--------|------------|------------|----------|
| 204117 | 1X55W      | 1          | 21,00 \$ |

**Tavan Armatürü Popart**



IP 20 ☺

| Kod No | Özellikler | Koli Adedi | Fiyat    |
|--------|------------|------------|----------|
| 204126 | 1X55W      | 1          | 21,00 \$ |

**Tavan Armatürü Miro S**



IP 40 ☺

| Kod No | Özellikler | Koli Adedi | Fiyat    |
|--------|------------|------------|----------|
| 204094 | 2XE27      | 12         | 10,50 \$ |

**Tavan Armatürü Hisar**



Alüminyum Enjeksiyon

IP 65 ☺

| Kod No | Özellikler | Koli Adedi | Fiyat    |
|--------|------------|------------|----------|
| 203963 | 2xE27      | 6          | 16,50 \$ |

**Tavan Armatürü Polo 4**



IP 40 ☺

| Kod No | Özellikler | Koli Adedi | Fiyat   |
|--------|------------|------------|---------|
| 204562 | Polo 4 E27 | 8          | 8,21 \$ |

**Downlight Çift Renkli 3+2W Sırma Sıva Altı**

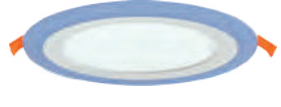

IP 40 ☺

| Kod No | Özellikler             | Koli Adedi | Fiyat   |
|--------|------------------------|------------|---------|
| 204207 | 3+2W S.A. 6500K + Mavi | 60         | 2,10 \$ |

**Dekoratif Aplik Club 3**



IP 20 ☺

| Kod No | Özellikler | Koli Adedi | Fiyat    |
|--------|------------|------------|----------|
| 203824 | E27        | 12         | 12,00 \$ |

**Dekoratif Aplik Piero**



IP 20 ☺

| Kod No | Özellikler | Koli Adedi | Fiyat    |
|--------|------------|------------|----------|
| 204558 | 4xG9       | 4          | 45,00 \$ |

**Dekoratif Aplik Costa 2**



IP 20 ☺

| Kod No | Özellikler | Koli Adedi | Fiyat    |
|--------|------------|------------|----------|
| 204540 | 2xGU10     | 2          | 15,85 \$ |

# Yerli Malı Belgeleri



LEDli Etanj Armatürler



LEDli Sıva Üstü Armatürler



LEDli Sıva Altı Armatürler



LEDli Yüksek Tavan Armatürleri



LEDli Projektörler



LEDli Yol ve Cadde Armatürleri

# TSE Belgeleri



## Yol ve Cade Armatürleri

## Projektörler



## Sıva Altı Armatürler

## Sıva Üstü Armatürler



## Anahtarlar

## Fiş ve Prizler

## Acil Aydınlatma Armatürleri



# ATEX Belgeleri

ATEX Belgeli Pelsan Exproof armatürler, tehlikeli gaz ve toz maddelerinin bulunduğu, patlama riski olan ortamlarda güvenle kullanılabilir.



## Türk Akreditasyon Sertifikası

Türk Akreditasyon Kurumu tarafından akredite olan laboratuvarımız ile tüm aydınlatma armatürlerini standartlara uygun olarak test ediyoruz.



# 100W Doka

Yol ve Cadde  
Armatürü

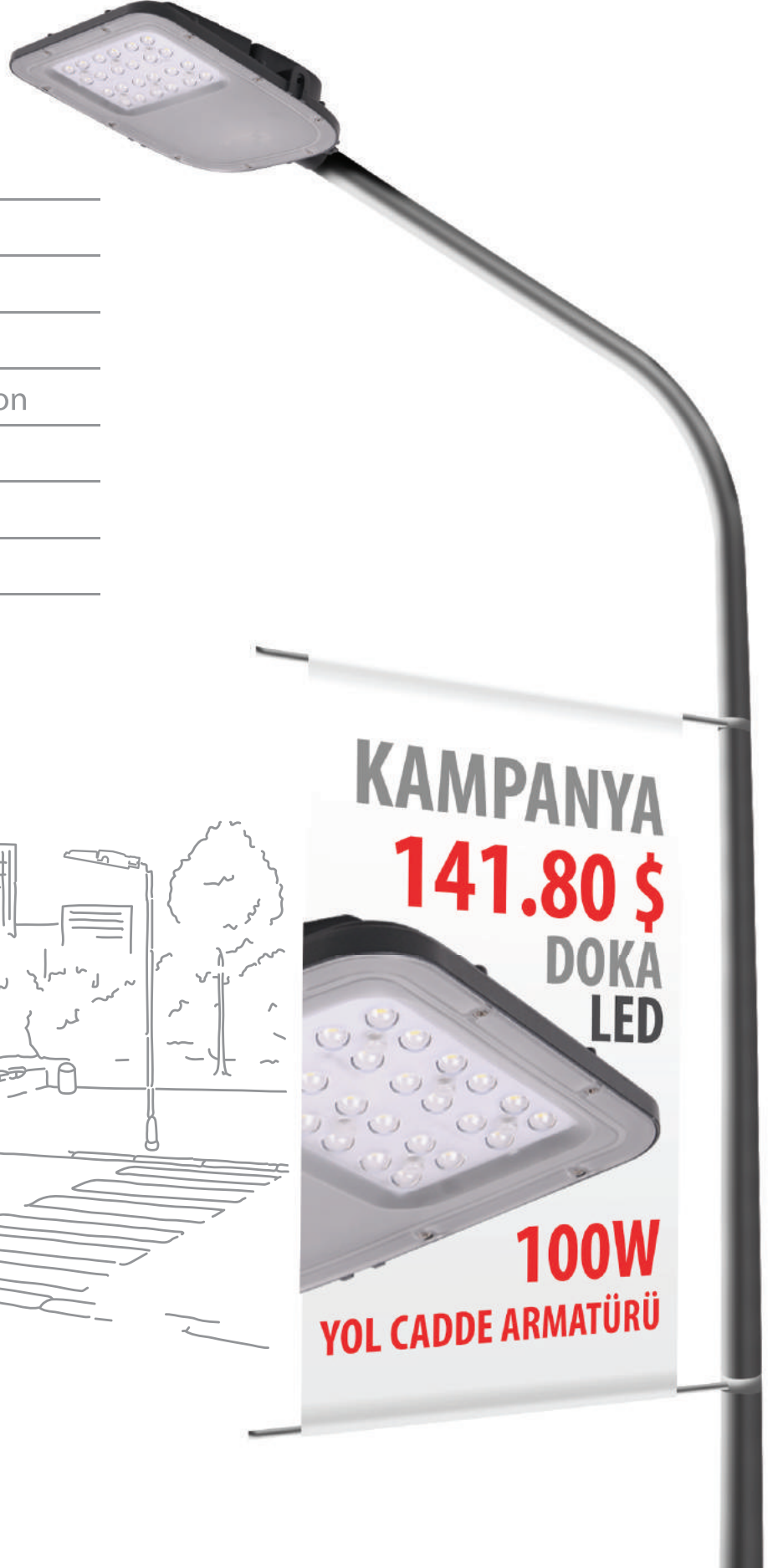

## Ürün Bilgileri

|             |                        |
|-------------|------------------------|
| Güç         | 50 / 80 / 100W         |
| Lümen       | 7600 / 10.800 / 13.300 |
| Im / W      | 150 / 136 / 133        |
| Gövde       | Alüminyum Enjeksiyon   |
| IP / IK     | IP66 / IK09            |
| Sürücü      | ENEC Belgeli           |
| Sistem Ömrü | +54.000 Saat           |

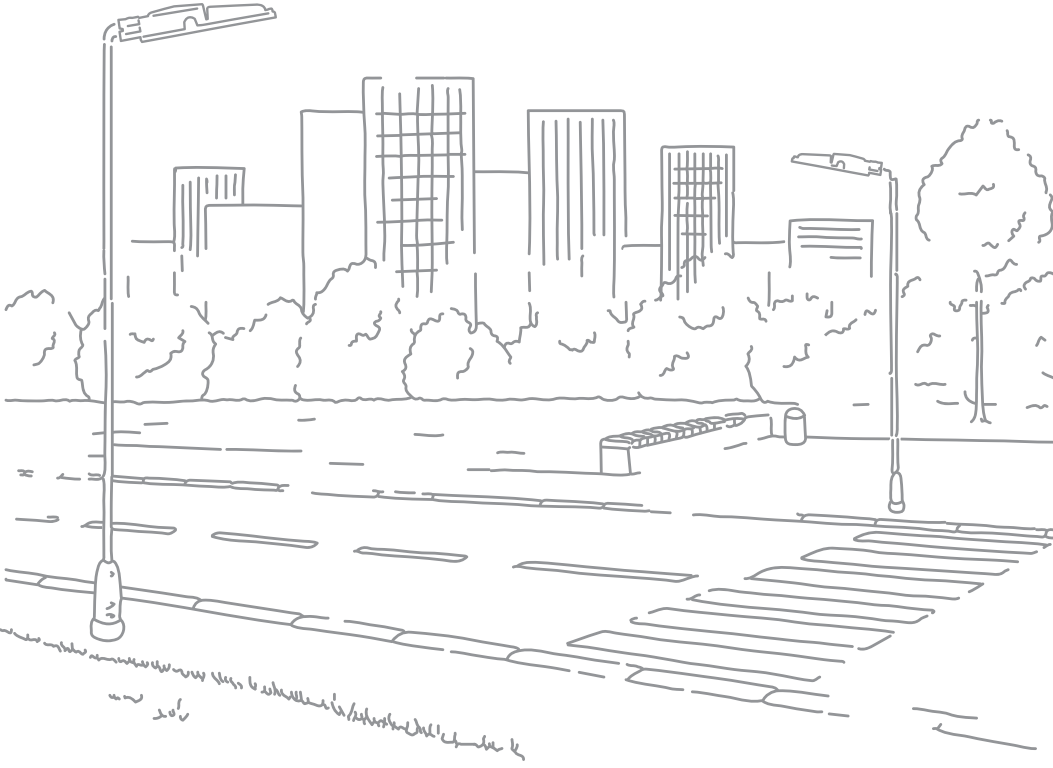

**KAMPANYA**

**141.80 \$**

**DOKA  
LED**

**100W  
YOL CADDE ARMATÜRÜ**

Güncel ürün bilgi ve belgeleri için [www.pelsan.com.tr](http://www.pelsan.com.tr)'yi ziyaret ediniz.

[www.pelsan.com.tr](http://www.pelsan.com.tr)  
[info@pelsan.com.tr](mailto:info@pelsan.com.tr) | [export@pelsan.com.tr](mailto:export@pelsan.com.tr)



**GENEL MERKEZ**  
İmes Sanayi Sitesi  
A Blok 101 Sk No.38  
Y. Dudullu / İstanbul  
Tel.: (0850) 460 75 76  
Faks: (0216) 364 60 15

**FABRİKA**  
Çerkeşli OSB İmes  
5. Cadde No.12  
Dilovası / Kocaeli  
Tel.: (0850) 460 75 76  
Faks: (0216) 364 60 15

**KARAKÖY MERKEZ**  
Emekyemez Mah.  
Yanıkkapı Porsuk Sk  
No. 11 Karaköy / İstanbul  
Tel.: (0850) 460 75 76  
Faks: (0216) 364 60 15

**PERPA BÖLGE OFİSİ**  
Perpa Ticaret Merkezi  
A Blok Kat: 9 No.1178  
Okmeydanı / İstanbul  
Tel.: (0850) 460 75 76  
Faks: (0216) 364 60 15

Fiyatlara KDV dahil değildir. Pelsan Aydınlatma gerekli koşullarda fiyat ve ürün değiştirme hakkını saklı tutar.